

Mondo Elite

CLASSIC

Introduction	4
Features	4
Safety and Care Information	5
Warnings	6
What's in the Box?	7
Mondo Elite Classic Controls	8
Remote Control	9
Qi Wireless Charging	9
Installation	10
Connect to a Wireless Network	10
Manually Connecting to a Wireless Network (optional)	11
My Stuff Folder, Web Portal Registration (optional)	12
Home Screen Icons	13
Navigation Basics	14
Chromecast built-in™	15
Before You Begin Streaming to the Mondo Elite Classic	15
Stream from Chromecast-Enabled Apps to Your Audio Device	15
Multi-Room Playback: How to Create an Audio Group	15
Play Audio on the Mondo Elite Classic from Google Home	16
Commonly Used Voice Commands to Control Your Internet Radio	17
Audio Sources	18
Bluetooth	18
Aux In	19
Playing Music from a USB Thumb Drive	19
Playing Music from a USB Hard Drive	19
UPnP Media Servers	20
Amazon Music Service	21
Enable Amazon Music Service	21
Pandora Music Service	25
Enable Pandora Music Service	25
Multi-Room Mode	27
Radio Settings	28
Alarm Clock and Time Options	28
Setting the Alarm Clock	29
Snooze Timer	31
Sleep Timer	31
Advanced Features (in the Radio Settings Menu)	33
Equalization Settings	33
Deep Sleep Mode	33
Master Power Off	33

Network Info	34
Firmware Update	34
Radio Info / Change Radio Name	34
Factory Reset	35
Display Settings	35
Troubleshooting	38
Product Specifications	40
Detail Streaming Support Protocols	41
Detail Audio Codec Support	42
Environmental Information	45
FCC Statement	46
Important Legal Information	47
End User License Agreement Terms and Conditions	47
Limited Manufacturer's Warranty	49

Features

Thank you for purchasing the Grace Digital Mondo Elite Classic. Your Mondo Elite Classic comes with everything you need to enjoy music in your home.

- Easy network set up wizard to connect to a wired or wireless network
- Large color display to show station and album artwork
- Powerful full room sound with equalizer settings
- Set multiple alarms, sleep, and snooze timers on the integrated clock
- 10 presets, save additional stations to 'My Stuff' folder
- Use Wi-Fi 802.11a/b/g/n/ac on 2.4 or 5 ghz networks with WEP and WPA / WPA2 personal support (does not support WPA2 enterprise)
- Integrated internet radio services
- Chromecast built-in for audio: stream music from hundreds of apps to your Chromecast-enabled speakers
- Integrated Bluetooth receiver to stream audio from a phone, and transmitter to stream to Bluetooth headsets
- Aux in for a wired connection to an audio device
- UPnP media player to play your saved music on your computer
- Multi-room audio via Chromecast built-in or Grace multi-room to stream aux in, UPnP, Bluetooth audio to every room of your house
- Integrated Qi wireless charging pad

Safety and Care Information





IMPORTANT! Always read and understand all the instructions to avoid injury to yourself and/or damage to your device. Grace Digital disclaims all responsibility for damage from data loss due to breakdown, repair, or other causes.

- Do not expose to extreme temperatures (above 140°F or below -4°F, or above 60°C or below -20°C).
- Do not expose to moisture. Do not use device near or in water.
- Do not let any foreign matter spill into device.
- Do not store in dusty areas.
- Do not expose to chemicals such as benzene and thinners. Do not use liquid or aerosol cleaners. Clean with a soft damp cloth only.
- Do not expose to direct sunlight for a prolonged period of time, and do not expose to fire, flame, or other heat sources.
- Do not try to disassemble and/or repair device yourself.
- Do not drop your device or subject it to severe impact.
- Do not place heavy objects on device.
- Do not subject device to excessive pressure.
- If the screen is damaged, do not touch the liquid crystal fluid.
- Remove metal protective or magnetic case from phone before wireless charging.
- When wirelessly charging your device, do not place magnetic-stripped or other metal objects on the charger. Doing so could damage the object or this unit.
- Qi compatible phones with metallic looking finishes will charge normally.

WARNING!!

- Opening the case may result in electric shock.
- Make sure that you insert the plug all the way into the outlet.
- Do not touch the device with wet hands.
- Do not install near any heat sources such as radiators, heat registers, stoves, or other apparatus (including amplifiers) that produce heat.
- Do not defeat the safety purpose of the polarized or grounding type plug. A polarized plug has two blades with one wider than the other. When the provided plug does not fit into your outlet, consult an electrician for replacement of the obsolete outlet.
- Protect the power cord from being walked on or pinched particularly at plugs, convenience receptacles, and the point where they exit from the apparatus.
- This product contains chemicals known to the State of California to cause cancer and birth defects or other reproductive harm.
- This device should be unplugged from the AC outlet during a thunder and lightning storm, and when the device will not be used for an extended period of time.
- Use the power plug to disconnect the device from the power source. To begin using the device again, reconnect it to an AC outlet.
- Connect the device to an easily accessible AC outlet, so that the device can be quickly disconnected, if necessary.

**CAUTION**
RISK OF ELECTRIC SHOCK
DO NOT OPEN

CAUTION: TO REDUCE THE RISK OF ELECTRIC SHOCK, DO NOT REMOVE COVER (OR BACK). NO USER-SERVICEABLE PARTS INSIDE. REFER SERVICING TO QUALIFIED SERVICE PERSONNEL.

 When found on the apparatus, the lightning flash with arrowhead symbol indicates hazards arising from dangerous voltages.

 When found on the apparatus, the exclamation point within an equilateral triangle symbol indicates the user should read all safety statements found in the user's manual.

 When found on the apparatus, the double box symbol indicates double insulation.

WARNING
TO REDUCE THE RISK OF FIRE OR ELECTRIC SHOCK, DO NOT EXPOSE THIS APPARATUS TO RAIN OR MOISTURE.

What's in the Box?

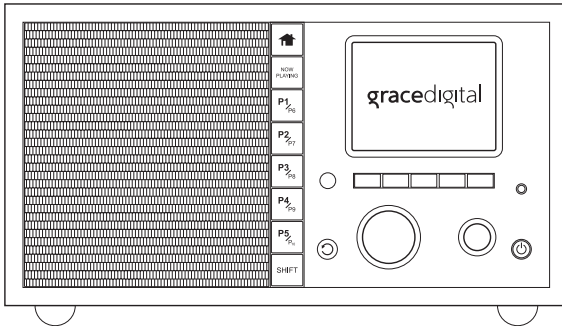

Mondo Elite Classic

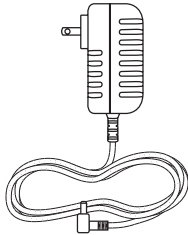

AC Power Adapter



Remote Control



2 Remote Batteries



2 External Antennas

Mondo Elite Classic Controls

Home Button

Press to toggle between the Home Menu / Now Playing Screen.

Action Panel Button/Now Playing

While at the Now Playing screen, press to learn more about the channel, show, or artist, and for additional selection options.

Context Sensitive Buttons

These buttons change their functions according to the context. Press to select the function shown on the display screen just above the button.

BACK Button

Press to return to the previously displayed screen.

P1 - P10 Number Buttons

Press and hold to set the station you are currently listening to. Press to play a previously saved station. See "My Stuff Folder, Web Portal Registration (Optional)" to save more favorite stations.

Tune Knob (Multifunction)

Turning the knob in a menu or user input screen scrolls through and highlights menus and choices; pressing the knob in a menu or user input screen selects the highlighted item.

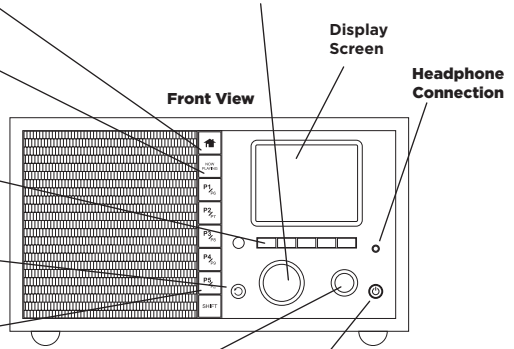

Volume / Mute Knob

Turn to adjust the volume; press down to mute and un-mute audio.

Power/Standby Button

Press to turn On/Standby.

Top View

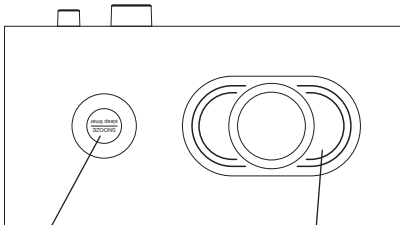

Sleep / Snooze Button

During an alarm press to snooze the alarm for 10 minutes or set snooze time; at the Now Playing screen press to set the sleep timer.

Wireless Fast Charging Pad

Charge your devices wirelessly by centering them on the charging pad. Your smartphone's charging icon will indicate once it has started charging. (Feature only works with devices that are wireless-charging compatible).

Rear View

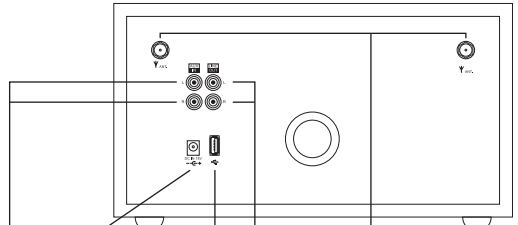

Power Connection

USB Connection

To charge smartphones, to play music from a USB thumb drive or USB hard drive, or for external, wired Ethernet Adapter, sold separately.

2 Standard SMA Female Coax Wi-Fi Antenna Connectors

Due to the metal back panel of the Mondo Elite Classic, installing external antennas are required for optimal performance. In the vast majority of situations the antennas can be oriented behind the radio facing sideways or down so you do not see them when viewing the radio from the front.

Aux In Connections

RCA Line Out Connections

Remote Control

Power/Standby Button

Press to turn On/Standby.

EQ, Alarm, Sleep, Snooze

Home Button

Press to display the Home screen.

Back Button

Press to return back to the previous display screen.

1-10 Number Buttons

Press and hold to set the station you are currently listening to. Press to play a previously saved station. See "My Stuff Folder, Web Portal Registration (Optional)" to save more favorite stations.

Battery Replacement

The Remote Control uses two AAA batteries.

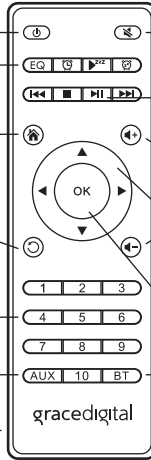

Mute Button

Press to silence the audio.

Play/Pause Button

Press to pause or resume playing. (Limited Support)

Vol+/Vol- Buttons

Press to increase or decrease the audio volume.

Arrow Buttons

Press in a menu or user input screen to scroll through and highlight menu items and choices.

Select Button

Press to select highlighted items.

Aux in Button

Select Aux in as audio source.

Bluetooth Button

Select Bluetooth as audio source.

Qi Wireless Charging

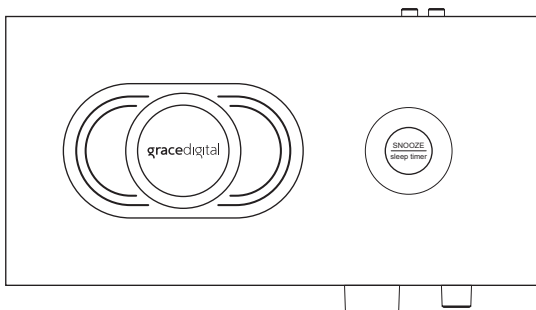

The Mondo Elite Classic has a 10 watts built-in fast Qi wireless charging pad on the top of the radio. The effective charging output to your phone is 7.5 watts. Center your phone on the charging pad, and read the status on the device you are charging to identify the charging status.

CAUTION: Remove metal or magnetic, protective case from phone before wireless charging. When wirelessly charging your device, do not place magnetic-stripped or other metal objects on the charger. Doing so could damage the object or this unit. Qi compatible phones with metallic looking finishes will charge normally.

Connect to a Wireless Network

The easiest way to connect to a wireless network is to have the Mondo scan for wireless networks, and then choose your wireless network from the list of wireless networks. The Mondo will automatically display the strongest Wi-Fi network at the top of the list.

However, if your wireless network name (SSID) is hidden, or if your network is DHCP disabled, you'll have to manually enter the network settings. Refer to "Manually Connecting to a Wireless Network" on page 11.

Turning the **Tune Knob** scrolls through menus and lists to highlight items, and pressing the **Tune Knob** selects a highlighted item.

Easy Connection to a Wireless Network

1. Plug the AC Power Adapter into an AC outlet, and plug the power plug into the connector on the rear of the Mondo Elite Classic. Press the **Power Button** if the Mondo Elite Classic does not automatically turn on.
2. If the Mondo Elite Classic has not previously connected to a wireless network, the Mondo Elite Classic will display the Network Wizard screen, with Wireless highlighted. Press the **Tune Knob**.

Otherwise, press the **Home Button**, turn the **Tune Knob** to highlight Setup and press the **Tune Knob** to select. Turn the **Tune Knob** to highlight Network Wizard and press **Tune Knob** to select. Wireless will be highlighted; press **Tune Knob** to select.

3. At the Wireless screen, Scan will be highlighted. Press the **Tune Knob** to select.
4. Wait while the Mondo Elite Classic scans for wireless networks and then select your wireless network from the list. Turn the **Tune Knob** to highlight your wireless network and then press the **Tune Knob** to select.
5. The Mondo Elite Classic will attempt to connect to the wireless network. If you chose a network that requires a password, you will be prompted to enter the network password. Password will be highlighted. Press the **Tune Knob** to begin entering the password. Otherwise, the Mondo Elite Classic will attempt to connect to the wireless network.
6. To enter the network password, turn the **Tune Knob** to highlight each character of the password and press the **Tune Knob** to select the character. Then enter the next character and continue until you have finished entering the password. If you make an error, press the **Delete Button** to erase the character. When you have completed entering the network password, press the **Submit Button**.

7. When the Mondo Elite Classic has successfully connected to the wireless network, "Connected successfully" will be displayed.

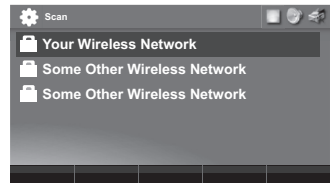
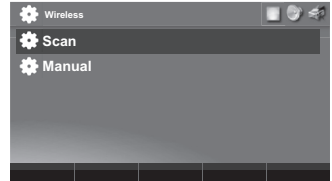

Manually Connecting to a Wireless Network (Optional)

To manually connect to a wireless network, you'll need to know the SSID (wireless network name), password, and type of encryption, and also may need additional information about your wireless network if it is not DHCP enabled:

SSID (wireless network name)	
Password	
Encryption (None, WEP, WPA-PSK)	
IP (Address for the Mondo Elite Classic)	
Mask (Network Mask IP Address)	
Gateway (Gateway IP Address)	
DNS (Primary Name Server IP Address)	

Plug the AC Power Adapter into an AC outlet, and plug the power plug into the connector on the rear of the Mondo Elite Classic. Press the **Power Button** if the Mondo Elite Classic does not automatically turn on.

- If the Sound System has not previously connected to a wireless network, the Mondo Elite Classic will display the Network Wizard screen, with Wireless highlighted. Press the **Tune Knob**.

Otherwise, press the **Home Button**, turn the **Tune Knob** to highlight "Radio Settings" and press the **Tune Knob** to select. Turn the **Tune Knob** to highlight Network Wizard and press **Tune Knob** to select. Wireless will be highlighted; press **Tune Knob** to select.

- At the Wireless screen, Scan will be highlighted. Turn the **Tune Knob** to highlight Manual and then press the **Tune Knob**.

- SSID (wireless network name) will be highlighted. Press the **Tune Knob**. Enter the SSID by turning the **Tune Knob** to highlight each character of the SSID and press the **Tune Knob** to select the character.

If you make an error, press the **Delete Button** to erase the character. When you have completed entering the SSID, press the **Submit Button**.



- Turn the **Tune Knob** and highlight Password. To enter the password, turn the **Tune Knob** to highlight each character of the password and press the **Tune Knob** to select the character. If you make an error, press the **Delete Button** to erase the character. When you have completed entering the password, press the **Submit Button**.
- Turn the **Tune Knob** and highlight Encryption. Turn the **Tune Knob** to highlight the type of encryption and press the **Tune Knob** to select.
- If DHCP is enabled on your wireless network, turn the **Tune Knob** and highlight DHCP Connect and press the **Tune Knob**. Skip ahead to step 12.

If DHCP is not enabled on the wireless network, turn the **Tune Knob** and highlight Static IP and press the **Tune Knob**.

- IP will be highlighted. Press the **Tune Knob** to select. Enter the IP Address. The IP address must be entered in the xxx.xxx.xxx.xxx format. When you have completed entering the IP address, press the **Submit Button**.
- Enter the Network Mask in the same way as you entered the IP Address.

16. Enter the Gateway IP Address in the same way.
17. Enter the DNS IP Address in the same way.
18. When all the information has been entered, turn the **Tune Knob** to highlight Connect and press the **Tune Knob**.
19. The Mondo Elite Classic will attempt to connect to the wireless network, and will display "Connected successfully" if the connection to the wireless network was successful. If the Mondo Elite Classic cannot connect to the wireless network, there is likely an error in the information that was entered.

My Stuff Folder, Web Portal Registration (Optional)

The radio works perfectly without registering your radio. However, registering your radio allows a few extra features. It allows you to search our internet radio station database online as well as Apple's podcast database via your computer's web browser and save your favorite internet radio station and podcast show instantly to your internet radio (this is much easier than searching on the radio itself!). Additionally, our Web Portal allows you to add your favorite radio station or podcast directly to your radio if we don't already have it in our database.

1. Go to **www.myradioplus.gracedigital.com** and click **Registration** to create an account.
2. In the menu on the left hand of the browser select **Radios**.
3. In the upper left hand corner select **Add New**.
4. Enter your radio's internal serial number.

NOTE: The serial number required to register your radio is not the serial number on the bottom of the radio. To find your internal serial number please go to your radio's home menu and select **Radio Settings** then select **Radio Info**. On the radio info screen, below the words **---Serial Number:---**, is the serial number you will need to enter. The number starts with 'gdi'. Please enter the entire serial number into the web portal including 'gdi' in the serial area then select **Save**.

Now you can directly save stations on the web site and add stations and podcast directly into the **My Stuff** folder on your radio.

To locate the **My Stuff** folder go to your radio's Home Screen and turn the **Tune Knob** to highlight Internet Radio and press the **Tune Knob**. My Stuff is the 3rd selection down.

To save a Station: On the left hand side of the web portal select **Favorites**, then select **Search and Save a Station**. Then enter in the call sign for the station you want to search for (or just search for a genre or station by location) and when you find a station you want to save to your radio select **Add to Favorites** on the right hand side of the resulting station listing(s).

To save a Podcast: On the left hand side of the web portal select **Favorites**, then select **Search and Save a Podcast**. Then enter in the podcast name for the podcast you want to search for (or just search for it by the network name or Category) and when you find the podcast you want to save to your radio select **Add to Favorites** on the right hand side of the resulting station listing(s).

To add a favorite Podcast or Stream that we don't have in our databases, select **Add a Podcast** or **Add a Stream** in the **Favorites** menu on the web portal and add the source audio URL. If you do not know the source URL (not just the station URL but the actually URL used to stream music) please contact the podcast or station owner directly.

The Home screen provides access to the different functions of the Mondo Elite Classic. You can navigate the Home screen by pressing **Home**, turning the **Tune Knob** to highlight an item, and pressing the **Tune Knob** to select.

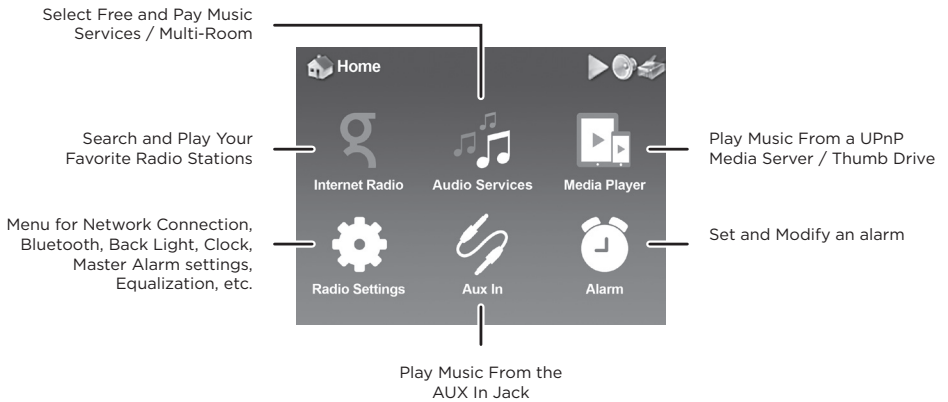

Power Button

The **Power Button** turns the Mondo Elite Classic on or places it in Standby Mode. Also press to turn an alarm off.



SNOOZE / Sleep Timer Button

Sleep: When the radio is playing, pressing the **SNOOZE / Sleep Timer Button** then select hours + press the **Tune Knob** then select minutes and press in **Tune Knob**.



Snooze: Pressing the **SNOOZE / Sleep Timer Button** when an alarm is sounding will set a snooze time of 5 minutes, or you can select the amount of snooze time. To cancel the snooze timer (or cancel an alarm) press the **Power Button**.

To adjust the Sleep or Snooze time to a time other than 5 minutes, press the **SNOOZE / Sleep Timer Button** and turn the **Tune Knob** to adjust the amount of sleep time, hours first, and then press the **Tune Knob** to select the hour setting. Do the same for the minutes.

Context Sensitive Buttons (5)

These buttons change their functions according to the context. Press to select the function shown on the display screen just above the button.



These buttons are described in this User Guide in the context where they appear.

Tune Knob

The **Tune Knob** is multifunction: you can turn it clockwise or counter-clockwise and press it.



Turn: Turning the **Tune Knob** when you are on the Now Playing screen will bring up the previous menu. When in menus or user input screens, turning the **Tune Knob** scrolls through and highlights menu items and choices.

Volume Knob

Turning the **Volume Knob** clockwise or counter-clockwise increases or decreases the volume of the audio. Pressing the **Volume Knob** mutes and un-mutes the audio.



Presets P1 - P10

The **Presets** are used to store favorite channels in the button location by pressing and holding the button. Then you can tune a favorite channel just by pressing the button. Pressing **SHIFT** allows you to program 6-10 presets.



The radio currently can only save presets of content found directly on the Mondo Elite Classic. It cannot save Bluetooth®, UPnP, Aux In, or Chromecast built-in as favorites.

BACK Button

The **BACK** Button returns back to the previously displayed screen or Home Screen.



Home Button

Pressing the **Home Button** will bring you back to the main Home Screen.



Now Playing Button

Pressing the **Now Playing Button** will take you back to the Now Playing screen. If you are already on the Now Playing screen, it will display the audio stream details.



With Chromecast built into your Mondo Elite Classic, you can stream your favorite music from your phone, tablet or laptop right to your speakers. Easily control your speakers with hundreds of apps you already know and love from your iPhone®, iPad®, Android™ phone or tablet, Mac® or Windows® laptop, or Chromebook.

Before You Begin Streaming to the Mondo Elite Classic

In order to stream to the Mondo Elite Classic, it must be on the same local network as the device (smartphone, tablet, laptop, PC etc.) that you will stream from. Please see the previous installation section in this manual on how to connect to a wireless network. Once your Mondo Elite Classic is connected to the network there is no additional set up required on the Mondo Elite Classic to enable Chromecast built-in.

In order to insure the best experience, please make sure you are running the latest version of the Chromecast-enabled app on your smartphone / tablet etc. You can always double check that you are on the latest version by visiting Google Play or Apple App Store and checking for any app updates.

Stream from Chromecast-Enabled Apps to Your Audio Device

To stream from your mobile device or tablet to the Mondo Elite Classic:

1. Open a Chromecast-enabled app.
2. In the top right or bottom right corner, tap the Cast button .
3. Choose the Mondo Elite Classic. The Cast button will become filled, letting you know you're connected.
4. Once you are connected, you can stream music, radio stations, and podcasts directly to the Mondo Elite Classic.

Multi-Room Playback: How to Create an Audio Group

Multi-room playback allows you to stream the same music to several speakers at the same time. You can use this feature to enjoy your music all around your home. Once you've created your group, your favorite music and audio from Chromecast-enabled apps are instantly available to stream.

Create an Audio Group:

1. Make sure all audio devices and your mobile device or tablet are connected to the same Wi-Fi network.
2. Open the Google Home app
3. At the top left, tap **Add** and then **Create speaker group**.
4. Tap each device you want to add to the group. A check will appear next to each device you select.
5. Tap **Next** > Enter a name for your group > **Save**.

NOTE: Multi-room group creation functionality is only available on iOS and Android. This feature is not supported from the Chrome browser. However, you can still stream to a group from Chrome.

For additional tips and troubleshooting please view the Google Home app or Google support at <https://support.google.com/chromecastbuiltin>

Play Audio on the Mondo Elite Classic from Google Home

Initiate and control audio to the Mondo Elite Classic with Chromecast built-in — using only your voice. Please follow the previous steps in the previous Chromecast section of the menu.

1. Make sure your Mondo Elite Classic is set up and connected to the same Wi-Fi as your mobile device or tablet and speaker or display.
2. Open the Google Home app.
3. At the top right, tap your account.
4. Verify that the Google Account shown is the one linked to your Google Home or Google Nest device. To switch accounts, tap another account or **Add another account**.
5. Tap **Assistant settings > Devices > Add**.
6. The Google Home app will search for remote devices on the same Wi-Fi network as your Mondo Elite Classic.

NOTE: You may see a list of devices that aren't voice-supported. These can't currently be linked to your speaker or display, but they'll be available soon.

7. To add a device, tap the check next to the device name. You can select multiple devices. Tap **Add**.
8. You'll see linked remote devices TVs and speakers section of the Google Home app.

NOTE: If you receive an "Error when linking device" error message, you must factory reset your Chromecast device.

To Unlink a Device:

1. Make sure your mobile device or tablet is connected to the same Wi-Fi as your Mondo Elite Classic.
2. Open the Google Home app.
3. From your home screen, tap the device you want to remove.
4. Tap **Settings** and then **Remove device** and then **Remove**.

Commonly Used Voice Commands to Control Your Internet Radio

To do this...	Just say "Hey Google" to get started
Request a song	<ul style="list-style-type: none"> • Play <song name> • Play <song name> by <artist name> • Play <song name> on <music service>
Request an artist	<ul style="list-style-type: none"> • Play <artist name> • Play <artist name> on <music service>
Request an album	<ul style="list-style-type: none"> • Play <album name> • Play <album name> by <artist name> • Play <album name> by <artist name> on <music service>
Play music based on genre/mood/activity	<ul style="list-style-type: none"> • Play music for sleeping • Play relaxing sounds
Play personalized suggested content from chosen service	<ul style="list-style-type: none"> • Play some music • Play <genre> music on <music service>
Play music on your speakers, TV, or video device. NOTE: Device linking is required.	<ul style="list-style-type: none"> • Play music on my living room TV • Play <genre> on my bedroom speakers
Pause	<ul style="list-style-type: none"> • Pause • Pause the music
Resume	<ul style="list-style-type: none"> • Resume the music
Stop	<ul style="list-style-type: none"> • Stop • Stop the music
Play next song	<ul style="list-style-type: none"> • Play next song
What's playing	<ul style="list-style-type: none"> • What song is this?"
Control Volume	<ul style="list-style-type: none"> • Decrease volume • Decrease volume by 20% • Turn up the volume • Volume level 7 • Increase volume by 20%

Google, Android, Google Play, Google Home, and other marks are trademarks of Google LLC."

In addition to being able to play music via Chromecast-enabled apps, you can also play music via Bluetooth, USB drives, UPnP media players, the aux in jack, as well as the music services directly on the radio.

To play a music service on the radio, you can select the appropriate music service or Grace Digital radio service by using the front panel controls, the infra-red remote control, or the free Android or iPhone apps.

The music services currently available on the radio are: Amazon Music (An Amazon Prime subscription or an Amazon Music Unlimited subscription is required and sold separately by Amazon; Amazon Music Prime, Amazon Music Unlimited, and Amazon HD coming soon), Pandora, CBS radio (radio.com), BBC, NPR, iHeartRadio (basic stations only, for advanced features please use the Chromecast-enabled app), SiriusXM (A SiriusXM Streaming Subscription is required and sold separately by SiriusXM. See SiriusXM Customer Agreement at siriusxm.com for details.), SHOUTcast, Calm Radio, Live 365, Sleep Sounds, and Podcasts via iTunes Podcast database.

Bluetooth

The Mondo Elite Classic can work as a Bluetooth speaker. When you power the Mondo Elite Classic on for the first time the Mondo Elite Classic will automatically be available to connect. If it is not showing up on your smartphone, go into the Mondo Elite Classic main 'Radio Settings' menu, select Bluetooth. If the menu item **Bluetooth Pairing Mode** is displayed on the radio, then you should see it on your smart device. Once you select the Mondo Elite Classic in your smart device the radio will now show the name of the smartphone / tablet that it is paired too.

Now on your smart device simply press play on the music that you want to stream via Bluetooth and the music will start playing on the Mondo Elite Classic. After your initial set up, the next time you want to play Bluetooth you will have to select the device from the Mondo Elite Classic menu.

For example, if you are playing Bluetooth music from your smartphone and you then later press the preset 1 on the Mondo Elite Classic to play your previously saved radio station. To play Bluetooth music again you will have to select your device from the Mondo Elite Classic Bluetooth menu. After you select your device you will be shown 3 options:

Play: If you want to play the music.

Disconnect: If you want to stop playing music but keep the smartphone device in the Mondo Elite Classic memory. By doing this, it will release your smartphone from playing music but if you later press play on the Mondo Elite Classic, assuming your device is still in range, pressing play on the Mondo Elite Classic will start playing music from your device again.

Unpair: Will disconnect the Mondo Elite Classic and place the Mondo Elite Classic into pairing mode to be paired to another phone.

NOTE: If you unpair your smart device and then want to pair back to the Mondo Elite Classic again, depending on the smart device you may have to delete the Mondo Elite Classic name out of your device's Bluetooth list, or turn Bluetooth on and off on your smart device. Then the Mondo Elite Classic will display again and you can repair, connect, and start playing.

Bluetooth Transmission to a Bluetooth Headphone:

The Mondo Elite Classic can also play music through Bluetooth enabled headphones / earbuds.

1. Make sure that your Bluetooth device is turned on and ready to pair. (If you are not familiar with Bluetooth pairing for your Bluetooth headphones, or other Bluetooth enabled device, refer to its user guide.)
2. On the Mondo Elite Classic, press the **Home Button** and turn the **Tune Knob** to highlight Radio Settings. Press the **Tune Knob** to select.
3. Turn the **Tune Knob** to highlight Bluetooth and press the **Tune Knob** to select.
4. The available Bluetooth devices should appear. Turn the **Tune Knob** to highlight the one with which you wish to pair and press the **Tune Knob** to select.
5. Press the **Tune Knob** to select Pair BT headphone/speaker. Most headphones will emit a verbal confirmation or a tone to indicate that pairing was successful.
6. Press the **Tune Knob** to select Connect to BT headphone/speaker. Once connected, you will be able to stream your internet radio stations from the Mondo Elite Classic to your Bluetooth headphones. (The headphones must be paired first, then connected to the Mondo Elite Classic for this feature to be fully enabled.)
7. If you wish to pair to a different device, use the **Tune Knob** to navigate to the Bluetooth folder again and turn the **Tune Knob** to highlight Disconnect. If you wish unpair the headphones, turn the **Tune Knob** to highlight Unpair.

NOTE: This feature disables the internal speaker on the Mondo Elite Classic while connected to the Bluetooth receiving device. Chromecast built-in also does not work. As such, Multi-Room Mode and Bluetooth streaming from your smartphone or other device are also disabled.

Aux In

You can listen to another device such as an MP3 player or Smartphone by plugging it into the Aux In connection on the Mondo Elite Classic.

To Listen Using Aux In:

1. Connect a device to the Aux In connection on the Mondo Elite Classic.
2. Press **Home** and turn the **Tune Knob** to highlight **Aux In**. Press the **Tune Knob** to select.

To Exit Aux In:

1. Press the **Stop Button** to exit Aux In.

Playing Music from a USB Thumb Drive

Insert your USB thumb drive into the Mondo Elite Classic and on the radio menu select **Media Player** then select **USB**.

NOTE: USB sticks must be formatted in one of the following protocols: FAT, FAT32, NTFS, ext2, ext3 or ext4.

Playing Music from a USB Hard Drive

Connect your USB hard drive to the Mondo Elite Classic. If your drive requires more power, you may want to use a USB powered hub in between the Mondo Elite Classic and the USB hard drive, then select 'Media Player,' then select 'USB,' then you will be able to navigate and play your music using the **Tune Knob**.

UPnP Media Servers

The Mondo Elite Classic will play music from network connected UPnP or DNLA media servers. You must first make sure that the media server is on the same network as the Mondo Elite Classic, then select 'Media Player,' then select 'UPnP,' then select your device and you will be able to navigate and play your music using the **Tune Knob**.

NOTE: The Mondo Elite Classic is a media player and renderer. This means that the features and functionality are driven by your media player software. To optimize the performance, keep your media player folder size to a manageable size. The larger the folder size, the longer it takes the Mondo Elite Classic to display the folder content and scroll through them.

Additionally, check the product specifications section of the manual to see the supported protocols pages 43-46. If you have a mixture of supported and unsupported formats in a folder on your media server, depending on your software, the radio will be able to see all, some, or none of the folders. So, it is always best to make sure the folder you want the Mondo Elite Classic to access only has supported formats /bit rates etc.

Enable Amazon Music Service

The Mondo Elite Classic comes with an Amazon Music app. You will need either an Amazon Prime subscription or an Amazon Music Unlimited subscription to enable the Amazon Music service on your Mondo Elite Classic.

You can enable the Amazon Music service either on your radio web portal or with the Grace Digital app (iOS or Android). Please note that to be able to use the web portal or app, your PC or phone needs to connect to the same network as your radio.

Enable or Disable the Amazon Music service on your radio web portal:

To Enable the Amazon Music service, follow the steps below:

1. Add your speakers to your Wi-Fi network (see page 10).
2. Press **Home** and turn the **Tune Knob** to highlight Radio Settings. Press the **Tune Knob** to select.
3. Turn the **Tune Knob** to highlight the Network Info and press the **Tune Knob** to select. There you will find its IP address (e.g. 10.0.144.135).
4. Go to a web browser on your PC, enter the IP address of your radio.
5. After the web portal launch, go to Login with Amazon tab, click Login to Amazon.
6. Amazon Sign-In page will pop up, enter your Amazon account number and password.
7. After a successful Amazon log in, the web portal will show the service is available.
8. On the Mondo Elite, press **Home** and turn the **Tune Knob** to highlight Audio Services. Press the **Tune Knob** to select.
9. Turn the **Tune Knob** to highlight Amazon Music and press the **Tune Knob** to select. There you can turn the **Tune Knob** to search for music and press the **Tune Knob** to select and play.
10. Turn the **Tune Knob** to highlight My Music and press the **Tune Knob** to select. This folder is synced with My Music on the Amazon Music service. You will need to use the Amazon Music app to add or remove music from this folder.

Happy listening.

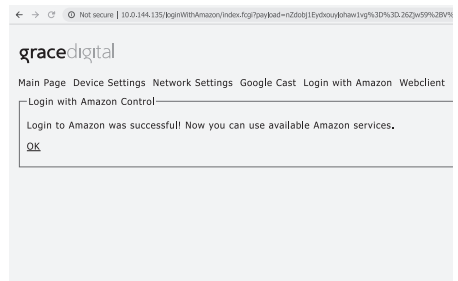
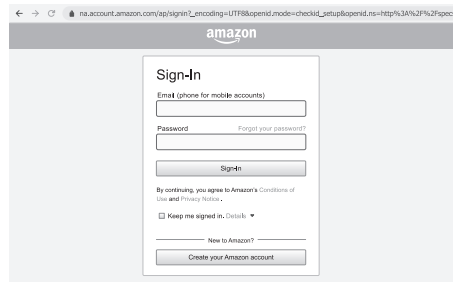
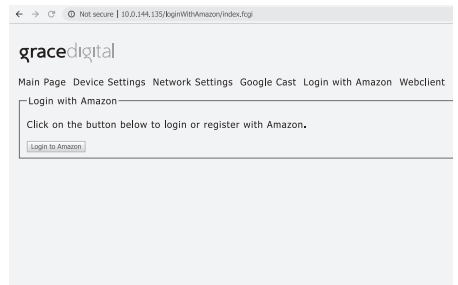

To Disable the Amazon Music service, follow the steps below:

1. Go to Login with Amazon tab on your radio web portal.
2. Click Unlink, the Amazon Music service will be disabled on your radio.

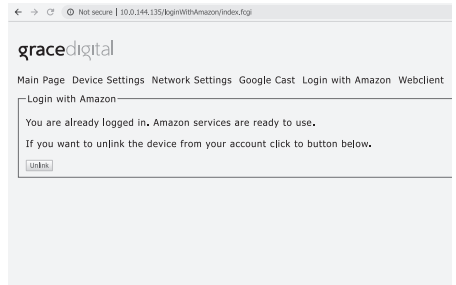

Enable or Disable the Amazon Music service with Grace Digital Android app:

To Enable the Amazon Music service, follow the steps below:

1. Before you launch the Grace Digital app, enable Bluetooth on your phone.
2. Launch the Grace Digital Android app, a device list will show.
3. Click ⊕ icon at the bottom-right corner, a Setup screen will pop up showing devices found.
4. Click the device name of your radio, an Amazon Sign-in page will pop up. Enter your Amazon account number and password.
5. After a successful Amazon log in, it will show the Setup screen. Note that under the device name, it now shows "Tap to Logout from Amazon", which indicates your radio has logged into Amazon service.
6. On the Mondo Elite, press **Home** and turn the **Tune Knob** to highlight Audio Services. Press the **Tune Knob** to select.
7. Turn the **Tune Knob** to highlight Amazon Music and press the **Tune Knob** to select. There you can turn the **Tune Knob** to search for music and press the **Tune Knob** to select and play.

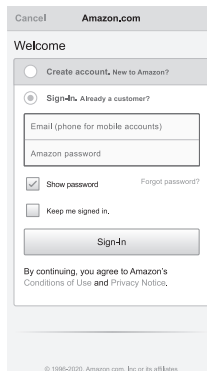

- Turn the **Tune Knob** to highlight My Music and press the **Tune Knob** to select. This folder is synced with My Music on the Amazon Music service. You will need to use the Amazon Music app to add or remove music from this folder.

Happy listening.

To Disable the Amazon Music service, follow the steps below:

- Launch the Grace Digital Android app, click  icon at the bottom-right corner to bring up the Setup screen.
- Click the device name of your radio, the Amazon Music service will be disabled on your radio.



Enable or Disable the Amazon Music service with Grace Digital iOS app:

To Enable the Amazon Music service, follow the steps below:

- Before you launch the Grace Digital app, enable Bluetooth on your phone.
- Launch the Grace Digital iOS app, a device list will show.
- Click Setup at the top-right corner, a Setup screen will pop up showing devices found.
- Click the device name of your radio, an Amazon Sign-in page will pop up. Enter your Amazon account number and password.

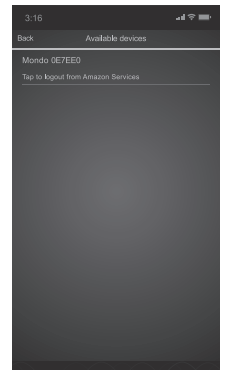
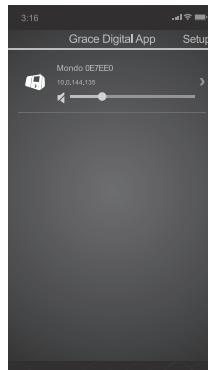

5. After a successful Amazon log in, it will show the Setup screen. Note that under the device name, it now shows “Tap to Logout from Amazon”, which indicates your radio has logged into Amazon service.
6. On the Mondo Elite, press **Home** and turn the **Tune Knob** to highlight Audio Services. Press the **Tune Knob** to select.
7. Turn the **Tune Knob** to highlight Amazon Music and press the **Tune Knob** to select. There you can turn the **Tune Knob** to search for music and press the **Tune Knob** to select and play.
8. Turn the **Tune Knob** to highlight My Music and press the **Tune Knob** to select. This folder is synced with My Music on the Amazon Music service. You will need to use the Amazon Music app to add or remove music from this folder.

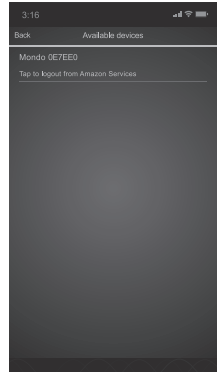
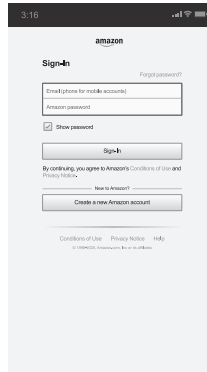

Happy listening.

To Disable the Amazon Music service, follow the steps below:

1. Launch the Grace Digital iOS app, click Setup at the top-right corner to bring up the Setup screen.
2. Click the device name of your radio, the Amazon Music service will be disabled on your radio.

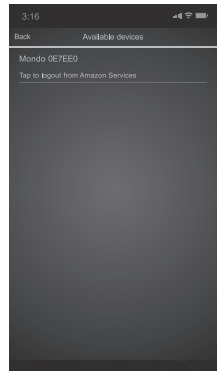

Enable Pandora Music Service

The Mondo Elite Classic comes with an Pandora music app. You will need a Pandora account to enable the Pandora music service on your Mondo Elite Classic.

To Enable the Pandora music service, follow the steps below:

1. Press **Home** and turn the **Tune Knob** to highlight Audio Services. Press the **Tune Knob** to select.
2. Turn the **Tune Knob** to highlight Pandora. Press the **Tune Knob** to select.
3. Turn the **Tune Knob** to highlight "Click here to get activation code." Press the **Tune Knob** to select. Take note of the code that appears on your screen. The code will remain valid for 10 minutes.
4. On your computer or smartphone, type www.pandora.com/gracedigital into your web browser. It will take you through a 3-step, setup process.
5. Enter the code displayed on your radio (e.g. F8BDEA35). Note that the code is case sensitive. Click, "Activate Now." This will bring you to second step.
6. If you have a Pandora account, click, "I have a Pandora Account." (If you don't, click, "Create a Pandora Account" and follow the prompts.) This will bring you to the third step.

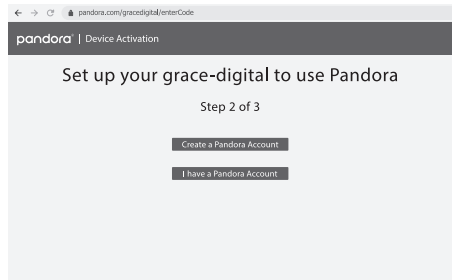
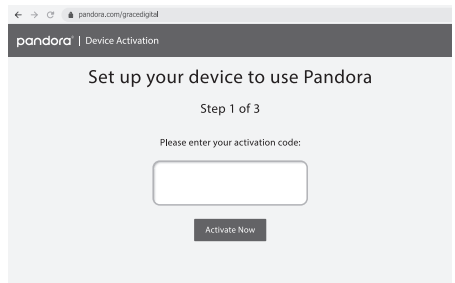
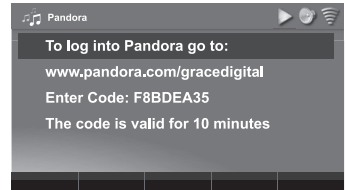
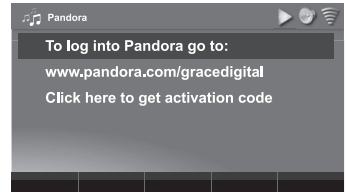

7. Enter your email and password, then click **Lookup Account**. If the setup is successful, the, "All done" screen will appear, stating that your radio is ready to use Pandora.
8. On the Mondo Elite Classic, press **Home**, turn the **Tune Knob** to highlight Pandora, and press the **Tune Knob** to select. There you can turn the **Tune Knob** to search for music and press the **Tune Knob** to select and play.

Happy listening.

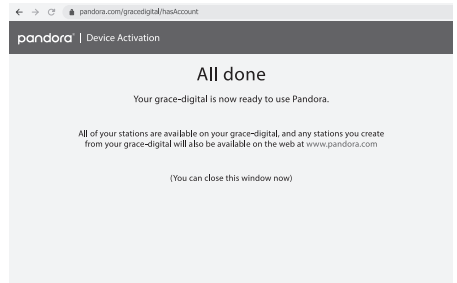
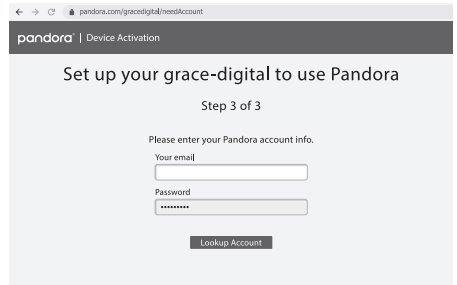

To play the same Chromecast built-in audio to multiple Mondo Elite Classic internet radios please see the Chromecast built-in section.

To play the same audio (other than Chromecast built-in audio) on multiple Mondo Elite Classic internet radios in your home or office you can create groups using the free Grace Controller apps for Android or iPhone. Please download the Grace controller apps on Google Play or the Apple app store and follow the instructions on the respective apps.

The Grace Controller app will allow you to stream any audio source including aux in, Media Players, USB media (except Chromecast built-in audio) simultaneously to groups of Mondo Elite Classic internet radios.

Additionally, on the radio, via the music services folder, you can select any other Mondo Elite Classic on your network and the Mondo Elite Classic will start playing the same audio that is currently playing on the selected radio (except Chromecast built-in audio).

For example: If you have your Mondo Elite Classic in your bedroom playing K-rock, and you want to play the same music on your Mondo Elite Classic in your kitchen, on your Kitchen Mondo Elite Classic select the music services icon and scroll to the bottom of the menu and select multi-room. In that menu you will see the list of other Mondo Elite Classic in your home. Select your bedroom radio and now both your bedroom radio and your kitchen radio will be playing K-rock synchronized.

To simplify your whole home experience you can change the name of your Mondo Elite Classic to any name you want such as kitchen, bedroom, den etc. To change the name of your Mondo Elite Classic go into the radio settings menu and select 'radio Info, then highlight and select device name. Change the name to what you want then select enter to save the new name. This new name will also display as the name for Bluetooth, Wi-Fi and Chromecast built-in connections.

Alarm Clock and Time Options

Clock set-up option has several selections:

24-Hour Time: This option sets the time format to a 12 or 24 hour format.

Alarm Clock: The Mondo Elite Classic has five alarm clocks, each of which can be configured differently. Refer to “Setting Alarm Clock” for information about the alarm clock.

Timezone: This option sets the Mondo Elite Classic to the timezone for your area. The radio will automatically adjust for daylight saving time.

Alarm Output: This feature allows the alarm sound to play out of both your connected headset and the internal speaker while your headset is plugged in, or allow the alarm to only be heard through your headset.

Alarm Fade-In: Enabling fade-in provides a gradual increase in alarm volume. Set the alarm to have no fade-in or set it from 10 seconds to 60 seconds.

Alarm Duration: If you don't disable your alarm when it goes off, your alarm will automatically continue to play for 1 hour. You can set the alarm duration to a shorter or longer duration using this feature.

Sleep Fade-Out: With this feature turned on, you can gradually reduce audio level as the sleep timer turns the Mondo Elite Classic off (from between 10 seconds to 120 seconds). This feature helps those who wake up if audio is shut off suddenly.

Default Snooze Time: This allows you to set the number of hours / minutes for the 1st press of the **SNOOZE / Sleep Timer Button**. For example, if you set the snooze time to 20 minutes, when the alarm is activated and you press the snooze button, the alarm will turn off and turn back on in 20 minutes. This setting only changes the 1st press of the button; the 2nd press and each additional press increments the timer by the default, which is 5 minutes. Pressing the power button will deactivate the snooze timer.

Default Sleep Time: This allows you to set the number of hours / minutes for the 1st press of the **SNOOZE / Sleep Timer Button**. For example, if you set the snooze time to 20 minutes, when you are listening to music and press the sleep timer the music will continue to play for 20 minutes. This setting only changes the 1st press of the button; the 2nd press and each additional press increments the timer by the default, which is 5 minutes. Additionally, while the sleep timer screen is active you can set it to the exact hours and minutes you would like the sleep timer to be active. Pressing the power button will deactivate the sleep timer.

To Enable or Disable 24-Hour Time:

1. Press the **Home Button** and turn the **Tune Knob** to highlight Radio Settings. Press the **Tune Knob** to select.
2. Turn the **Tune Knob** to highlight Alarm Clock and Time Options and press the **Tune Knob** to select.
3. Turn the **Tune Knob** and highlight 24-hour time.
4. Press the **Tune Knob** to enable 24-hour time (when the box has a checkmark in it), or disable (when the box does not have a checkmark in it).

To Select the Timezone:

1. Press the **Home Button** and turn the **Tune Knob** to highlight Radio Settings. Press the **Tune Knob** to select.
2. Turn the **Tune Knob** to highlight Alarm Clock and Time Options and press the **Tune Knob** to select.
3. Turn the **Tune Knob** to highlight a timezone and press the **Tune Knob** to select. A checkmark in the box next to the timezone indicates the selected timezone.

Setting the Alarm Clock

The Mondo Elite Classic has seven alarm clocks, each of which can be configured independently.

To Add or Modify an Alarm:

1. Highlight **Alarm** on the Home Screen and press the **Tune Knob**. (You can also access this menu when the radio is turned off by briefly pressing the **Home Button**. The audio will remain off during this mode.)
2. To add an alarm, press the **Add Alarm Button**, or to modify an alarm, turn the **Tune Knob** to highlight an alarm and press the **Modify Alarm Button**.
3. Each alarm has configuration options which are summarized in the following table. Turn the **Tune Knob** to highlight a configuration option and press it to select. Then turn the **Tune Knob** to change a setting and press it to confirm the setting.

Alarm Time	12:00 AM - 11:59 PM	Turn the Tune Knob to adjust the hour setting and press the Tune Knob to select. Turn the Tune Knob to adjust the minutes setting and press the Tune Knob to select.
Repeat	One Time, Everyday, Weekly, Weekdays, Weekends, Sunday, Monday, Tuesday, Wednesday, Thursday, Friday, or Saturday	Turn the Tune Knob to highlight the frequency of the alarm and press the Tune Knob to select.
Alarm Channel	Nine buzzer options or select 1 of your 10 presets	Turn the Tune Knob to highlight what you want to wake up to, and press the Tune Knob to select.
Volume	Variable	Turn the Tune Knob to adjust the volume of the alarm and press the Tune Knob to select.

4. When you finish configuring the alarm, turn the **Tune Knob** to highlight Save changes and press the **Tune Knob**. An advisory message will be displayed confirming the action selected.

To Enable, Disable, or Remove alarms:

1. On the Home Screen select Radio Settings and press the **Tune Knob**. Turn the **Tune Knob** to highlight Alarm Clock and Time Options and press the **Tune Knob**. Turn the **Tune Knob** to highlight Alarms and press the **Tune Knob**.
2. Turn the **Tune Knob** to highlight an alarm from the list and press the **Enable Alarm**, **Disable Alarm**, or **Remove Alarm Button**. An advisory message will be displayed confirming the action selected.

To Cancel an Alarm:

An upcoming alarm can be cancelled so that it does not sound. If the cancelled alarm has been configured as a repeating alarm, it will be reset to sound at the following scheduled time.

1. Press and hold the **Home Button** when in Standby Mode for 2 seconds.

The alarm icon will be removed from the display screen temporarily until after the scheduled time of the alarm has passed. This function **only** cancels the upcoming alarm, it does not disable an alarm series.

To Enable Alarm Output:

1. Press the **Home Button** and turn the **Tune Knob** to highlight Radio Settings. Press the **Tune Knob** to select.
2. Turn the **Tune Knob** to highlight Alarm Clock and Time Options and press the **Tune Knob** to select.
3. Turn the **Tune Knob** to highlight Alarm Output and press the **Tune Knob** to select.
4. Press the **Tune Knob** to enable Alarm Output through both the Internal Speaker and Headphone (when the box has a checkmark in it), or disable (when the box does not have a checkmark in it).

To Enable Alarm Fade-In:

1. Press the **Home Button** and turn the **Tune Knob** to highlight Radio Settings. Press the **Tune Knob** to select.
2. Turn the **Tune Knob** to highlight Alarm Clock and Time Options and press the **Tune Knob** to select.
3. Turn the **Tune Knob** and highlight Alarm Fade-In and press the **Tune Knob** to select.
4. Press the **Tune Knob** to enable Alarm Fade-In (when the box has a checkmark in it), or disable (when the box does not have a checkmark in it).
5. Turn the **Tune Knob** to highlight Fade-In Time and press the **Tune Knob** to select.
6. Turn the **Tune Knob** to adjust the chosen Fade-In Time (from 10 seconds to 60 seconds) and press the **Tune Knob** to select.

To Enable Alarm Auto Off:

1. Press the **Home Button** and turn the **Tune Knob** to highlight Radio Settings. Press the **Tune Knob** to select.
2. Turn the **Tune Knob** to highlight Alarm Clock and Time Options and press the **Tune Knob** to select.
3. Turn the **Tune Knob** and highlight Alarm Auto Off Enabled and press the **Tune Knob** to select.
4. Press the **Tune Knob** to enable Alarm Auto Off (when the box has a checkmark in it), or disable (when the box does not have a checkmark in it).

5. Turn the **Tune Knob** to highlight Alarm Duration and press the **Tune Knob** to select.
6. Turn the **Tune Knob** to adjust the chosen Alarm Duration and press the **Tune Knob** to select. (The default duration is 1 hour.)

Snooze Timer

When the alarm sounds, pressing the **SNOOZE / Sleep Timer Button** will silence the alarm for 5 minutes, or you can select a custom amount of time. After the snooze time elapses, the alarm will sound again.

To Snooze:

1. When the alarm clock is sounding, press the **SNOOZE / Sleep Timer Button** on the top of the Mondo Elite Classic once to select the default snooze time of 5 minutes. To select a longer snooze time, press the **SNOOZE / Sleep Timer Button** again to increase the time by 5 minutes. Each time the button is pressed the snooze time is increased by an additional 5 minutes.
2. Alternately you can also select a custom amount of snooze time. Press the **SNOOZE / Sleep Timer Button** and turn the **Tune Knob** to configure the amount of time, hours first and then minutes. Turn the **Tune Knob** to select the time and press the **Tune Knob** to confirm.
3. To change the default Snooze time of 5 minutes, press the **Home Button** and turn the **Tune Knob** to highlight **Radio Settings** and press the **Tune Knob**. Next highlight and press **Alarm Clock and Time Options** and then highlight and press **Default Snooze Time**. Turn the **Tune Knob** to configure the new default time, hours first and then minutes. Turn the **Tune Knob** to select the time and press the **Tune Knob** to confirm.

To Cancel a Current Snooze:

1. To cancel a current snooze (if you want to get out of bed and the snooze timer is counting down) press and hold the **Home Button** for 2 seconds (this only works during a snooze cycle while the radio is off/ in standby).

Sleep Timer

The sleep timer automatically turns the Mondo Elite Classic off after a period of time as you fall asleep. The period of time can be set up to 24 hours.

To Turn the Sleep Timer On:

1. When the Mondo Elite Classic is on, press the **SNOOZE / Sleep Timer Button** on the top of the Mondo Elite Classic once to select the default sleep time of 5 minutes. To select a longer time, press the **SNOOZE / Sleep Timer Button** again to increase the time by 5 minutes. Each time the button is pressed the sleep time is increased by an additional 5 minutes.
2. Alternately you can also select a custom amount of sleep time. Press the **SNOOZE / Sleep Timer Button** and turn the **Tune Knob** to configure the amount of time, hours first and then minutes. Turn the **Tune Knob** to select the time and press the **Tune Knob** to confirm.

3. To change the default Sleep time of 5 minutes, press the **Home Button** and turn the **Tune Knob** to highlight **Radio Settings** and press the **Tune Knob**. Next highlight and press **Alarm Clock and Time Options** and then highlight and press **Default Sleep Time**. Turn the **Tune Knob** to configure the new default time, hours first and then minutes. Turn the **Tune Knob** to select the time and press the **Tune Knob** to confirm.

To Cancel the Sleep Timer:

1. To cancel the sleep timer, press the **SNOOZE / Sleep Timer Button**, or press the **Power Button**. The advisory message **Sleep timer deactivated** will be displayed.

To Enable Sleep Fade-Out:

1. Press the **Home Button** and turn the **Tune Knob** to highlight Radio Settings. Press the **Tune Knob** to select.
2. Turn the **Tune Knob** to highlight Alarm Clock and Time Options and press the **Tune Knob** to select.
3. Turn the **Tune Knob** and highlight Sleep Fade-Out and press the **Tune Knob** to select.
4. Press the **Tune Knob** to enable Sleep Fade-Out (when the box has a checkmark in it), or disable (when the box does not have a checkmark in it).
5. Turn the **Tune Knob** to highlight Fade-Out Time and press the **Tune Knob** to select.
6. Turn the **Tune Knob** to adjust the chosen Fade-In Time (from 10 seconds to 120 seconds) and press the **Tune Knob** to select.

Equalization Settings

You can adjust the equalization of the Mondo Elite Classic (EQ) to adjust for room acoustics and your listening preferences. You can optimize your audio profile using the integrated 5 band equalizer, or you can select a Preset such as Rock, Jazz, etc.

To Change Equalization:

If you want to select an Equalization Preset, do the following:

1. Press **Home**, then select Radio Settings, then turn the **Tune Knob** to highlight Equalization. Press the **Tune Knob** to select.
2. Turn the **Tune Knob** to highlight Select EQ Preset and press the **Tune Knob** to select.
3. Turn the **Tune Knob** to highlight one of the Presets: Custom, Factory Default, Jazz, Talk, Rock, Classical, Vocal. Press the **Tune Knob** to select. A checkmark in the box next to the Preset indicates that it has been selected.

If you want to adjust the 5 band equalizer, do the following:

1. Press **Home**, then select Radio Settings, then turn the **Tune Knob** to highlight Equalization. Press the **Tune Knob** to select.
2. Turn the **Tune Knob** to highlight Modify Custom EQ and press the **Tune Knob** to select.
3. Turn the **Tune Knob** to highlight one of the 5 bands: 60Hz, 250Hz, 1KHz, 6KHz and 16KHz. Press the **Tune Knob** to select the band you wish to modify.
4. Turn the **Tune Knob** to adjust the equalization and press the **Tune Knob** to select the setting. Now you can turn the **Tune Knob** again to highlight another one of the remaining 4 bands, if you wish to make more adjustments.

Deep Sleep Mode

To place the radio into Deep Sleep mode, press the radio's or remote's **Power Button** for 3-4 seconds. To get out of Deep Sleep mode press the **Power Button** for 1-2 seconds. It will take the radio about 1 minute to completely power back on to be ready to play.

In Deep Sleep mode all functions are disabled including the alarm, remote, Wi-Fi, Ethernet, and Bluetooth connections. This reduces power consumption. Since all operations are turned off you will not be able to see the radio on your network or turn it back on with the infrared remote control. For typical daily use Deep Sleep mode is not suggested or needed.

Presets, settings, and passwords are saved even in deep sleep mode, and during power outages.

Master Power Off

In order to completely turn your radio off, without having to unplug the power cable please select **Master Power Off**. This will completely turn the radio off. All your settings, password, presets will remain saved in this mode. To delete all settings refer to **Factory Reset** on page 35.

Network Info

Network Info displays the details of the current network configuration of the Mondo Elite Classic. The MAC address of the Mondo Elite Classic can be found in the network info.

1. Press the **Home Button** and turn the **Tune Knob** to highlight Radio Settings. Press the **Tune Knob** to select.
2. Turn the **Tune Knob** and highlight Network Info and press the **Tune Knob** to select.
3. The current network configuration will be displayed. Turn the **Tune Knob** to scroll through the configuration details.

Firmware Update

Grace Digital may occasionally update the software for the Mondo Elite Classic and it is recommended that you always update the software when new software becomes available. The Mondo Elite Classic will automatically check for software updates when you turn it on, but you also can manually check for any available software updates.

1. Press the **Home Button** and turn the **Tune Knob** to highlight Setup. Press the **Tune Knob** to select.
2. Turn the **Tune Knob** to highlight Firmware Update and press the **Tune Knob** to select.
3. If the Mondo Elite Classic has already detected that a software update is available, it will show a software update available.

If not, the Mondo Elite Classic will check for a software update. If no update is available, the Mondo Elite Classic will display “No new updates”.

4. If a software update is available, turn the **Tune Knob** to highlight Install update and press the **Tune Knob** to select.
5. The software update will be applied to the Mondo Elite Classic. ***Do not turn the Mondo Elite Classic off during the update, or disconnect the Mondo Elite Classic power.*** When complete, the Mondo Elite Classic will restart to complete the update, and display “Please press the POWER button”.

Radio Info / Change Radio Name

The Info option displays information about the Mondo Elite Classic serial number and software version.

1. Press the **Home Button** and turn the **Tune Knob** to highlight Radio Settings. Press the **Tune Knob** to select.
2. Turn the **Tune Knob** to highlight Info and press the **Tune Knob** to select. The information will be displayed.

You can change the name of your radio by selecting Radio Info then highlight and select Device Name. The new name will now show up in Chromecast enabled apps, used for the Google assistant, and broadcast via Bluetooth.

Factory Reset

The Factory Reset option restores the Mondo Elite Classic to the factory settings. It will erase all the stored network settings, SiriusXM streaming username and password, presets, alarm clock settings, and set all other options back to the factory settings.

1. Press the **Home Button** and turn the **Tune Knob** to highlight Radio Settings. Press the **Tune Knob** to select.
2. Turn the Tune Knob to highlight Factory reset and press the Tune Knob to select.
3. Confirm that you really want to proceed with the factory reset. Confirm factory reset will be highlighted. Press the **Tune Knob** to proceed with the factory reset, or press the **BACK Button** to abort the factory reset.
4. The screen will display “Restoring factory defaults”, restart the Mondo Elite Classic when complete and display “Please press the POWER button”.

NOTE: You will have to connect the Mondo Elite Classic to a network (see “Connect to a Wireless Network”).

Display Settings

There are three different brightness backlight settings, and each type of backlighting can be set to a brightness from 0 to 20. In addition, each of the backlight settings can be set for two times of the day. This allows you to have two separate groups of settings, one for the daytime and one for the nighttime. Select the first option and set the time of day for that option, then you will be able to set the active, inactive, and standby settings for that time frame. Repeat the settings for your nighttime mode.

Active: This setting controls the brightness of the display screen when the Mondo Elite Classic is On, and you are interacting with the Mondo Elite Classic by pressing buttons, etc. After 30 seconds of inactivity, the display changes to the inactive setting.

Inactive: This setting controls the brightness of the display screen when the Mondo Elite Classic is On, but you have not interacted with the Mondo Elite Classic by pressing buttons, etc., for 30 seconds. You might use this setting to set the brightness when in a darkened room as you are falling asleep while listening to the Mondo Elite Classic.

Standby: This setting controls the brightness of the display screen when the Mondo Elite Classic is in Standby Mode.

To Set the Display Brightness:

1. Press the **Home Button** and turn the **Tune Knob** to highlight Radio Settings. Press the **Tune Knob** to select.
2. Turn the **Tune Knob** to highlight Display Settings and press the **Tune Knob** to select.
3. Turn the **Tune Knob** to highlight Display Brightness and press the **Tune Knob** to select.
4. Turn the **Tune Knob** and highlight Active, Inactive, or Standby and press the **Tune Knob** to select.
5. Turn the **Tune Knob** to the desired setting, 0 to 20 and press the **Tune Knob** to select your setting.

Optionally - When the radio is in Standby Mode, you can rotate the **Tune Knob** to temporarily change the standby backlight brightness. This is perfect to make the display 100% dark while sleeping, or brighter to see the clock.

To Set the Default Inactive Screen:

You can select either the Now Playing screen or large Time and Date Screen to be displayed when the music is playing.

1. Press the **Home Button** and turn the **Tune Knob** to highlight Radio Settings. Press the **Tune Knob** to select.
2. Turn the **Tune Knob** to highlight Display Settings and press the **Tune Knob** to select.
3. Turn the **Tune Knob** to highlight Default Inactive Screen and press the **Tune Knob** to select.
4. Turn the **Tune Knob** to highlight either Now Playing Screen or Large Time and Date Screen. Press the **Tune Knob** to select.

Inactive Display Time Delay:

Allows the ability to change the duration of time that the radio will take to go from your active backlight setting to the inactive setting.

1. Press the **Home Button** and turn the **Tune Knob** to highlight Radio Settings. Press the **Tune Knob** to select.
2. Turn the **Tune Knob** to highlight Display Settings and press the **Tune Knob** to select.
3. Turn the **Tune Knob** to highlight Inactive Display Time Delay and press the **Tune Knob** to select.
4. Turn the **Tune Knob** to highlight Playback or No playback and press the **Tune Knob** to select.
5. Turn the **Tune Knob** to adjust the chosen time delay and press the **Tune Knob** to select.

Clock Color:

Allows the ability to change the default clock color from Blue to Red. Red is the color that sleep experts often recommend for the best night's sleep.

1. Press the **Home Button** and turn the **Tune Knob** to highlight Radio Settings. Press the **Tune Knob** to select.
2. Turn the **Tune Knob** to highlight Display Settings and press the **Tune Knob** to select.
3. Turn the **Tune Knob** to highlight Inactive Display Time Delay and press the **Tune Knob** to select.
4. Turn the **Tune Knob** to highlight Clock Color and press the **Tune Knob** to select.
5. Turn the **Tune Knob** to highlight either Blue clock / blue background or Red clock / black background. Press the **Tune Knob** to select.

NOTE: The 2-3 darkest settings in Red Clock mode change the clock to a dark grey color to minimize the brightness of the display in a dark room.

Your Mondo Elite Classic has been designed and built to be trouble-free but if you experience a problem, here's some troubleshooting hints.

If you see this on the screen:	Try this:
Initializing Network Connecting to <wireless network> Error loading menu	<ul style="list-style-type: none"> • The Mondo Elite Classic is attempting to connect to your network. If this message is displayed more than one minute, make sure your network is connected to the Internet. <p>To verify that you have an Internet connection, refer to "Software Update" on page 37 and follow the procedure. If you receive the message No Update Available, or New version available, then the Radio is connected to the Internet. If you get the message, Login failed, then you don't have an Internet connection. Check with your network administrator for Internet connectivity on your network.</p> <ul style="list-style-type: none"> • Turn the Mondo Elite Classic Off and On again.
Buffering	<ul style="list-style-type: none"> • The Mondo Elite Classic is loading the channel information. If this message is displayed for more than one minute, make sure your connection to the Internet has not been interrupted. See Connecting (previous troubleshooting item) and verify your Internet connection. • Turn the Mondo Elite Classic Off and On again. • Try another channel / station.
Updating	<ul style="list-style-type: none"> • Your Mondo Elite Classic is installing a software update. Do not turn the Mondo Elite Classic off or disconnect the power. Allow the software update to complete.
Not Connected to the Internet Retrying	<ul style="list-style-type: none"> • The wireless network information you entered is incorrect. Verify and re-enter the information. • You have entered an incorrect password for a secure wireless network. Verify and re-enter the information. • If you have manually configured a network connection, you have entered one or more incorrect settings. Verify and re-enter the information.

If this happens:	Try this:
You do not receive the same Sirius or XM channels you receive on your Satellite Radio	<ul style="list-style-type: none"> • SiriusXM streaming does not have all of the same channels as the Sirius or XM satellite service. <p>Check siriusxm.com/channellineup for the latest SiriusXM streaming channel lineup.</p>
The Scan for Network feature fails before the Mondo Elite Classic connects to your network	<ul style="list-style-type: none"> • Your network has DHCP disabled. You'll have to manually configure your network connection. Refer to "Manually Connecting to a Wireless Network" on page 10.
The Scan for Network feature does not find your wireless network	<ul style="list-style-type: none"> • Your wireless network has a hidden name (SSID). If so, you will have to manually configure your wireless network connection. Refer to "Manually Connecting to a Wireless Network" on page 10. • The wireless signal from your access point is too low. Try moving the Mondo Elite Classic closer to your access point and see if the Scan for Network feature finds your wireless network.

Appendix

Mondo Elite Classic

Dimensions: 11.1 in (W) X 6.3 in (H) X 5.3 in (D)
280 mm (W) x 160 mm (H) x 135 mm (D)
Weight: 4.0 lbs, 12 oz (2.2 kg)

Power Adapter

Input: 100-240 VAC, 50/60 Hz, 1.8 A
Output: 18 VDC, 2.2 A

Remote Control

Dimensions: 1.5 in (W) x 3.375 in (H) x .25 in (D)
38 mm (W) x 86 mm (H) x 6 mm (D)
Weight: 0.6 oz (20 g)
Battery: AAA

Audio

Headphone: 3.5 mm diameter mini stereo jack
Line in: Left and right stereo RCA jacks
Line out: Left and right stereo RCA jacks
USB Audio: Standard USB jack (supports stereo)

Wireless Charging Pad

Qi Specification: 10-Watt system
Effective Power Output: 7.5 Watt
Qi Version: V1.2.4

Supported Audio Codecs

- MP3
- AAC
- FLAC
- LPCM/WAV/AIFF
- ALAC
- WMA, WMA9
- Ogg Vorbis

Supported Playlist

- ASX
- M3U
- PLS
- WPL

Supported Container Formats

- WAV
- M4A
- OGG
- AIFF

Supported Protocols

- SHOUTcast
- HTTPS
- WMA streaming
- RTSP/SDP

Supported MP3 encoding parameters

- Sampling rates [kHz]: 32, 44.1, 48
- Resolution [bits]: 16
- Bit rate [kbps]: 32, 40, 48, 56, 64, 80, 96, 112, 128, 160, 192, 224, 256, 320, VBR
- Channels: stereo, joined stereo, mono
- MP3PRO playback
- MP3 File extensions: *.mp3
- Decoding of ID3v1, ID3v2, MP3 ID tags including optional album art in .jpeg format up to 2 megapixels
- Gapless MP3: Playback is gapless if the container provides LAME encoder delay and padding tags.

Supported Vorbis encoding parameters

- Sampling rates [kHz]: 32, 44.1, 48
- Resolution [bits]: 16
- Nominal bit rate [kbps] (quality level): 80 (Q1), 96 (Q2), 112 (Q3), 128 (Q4), 160 (Q5), 192 (Q6),
- Channels: stereo
- The audio player supports reading of Vorbis content stored in Ogg containers. Supported file name extensions: *.ogg and *.oga.
- The audio player supports decoding of Vorbis comments.
NOTE: There is no specification for tag names. The system relies on the OSS implementation.
- Tag names decoded: TITLE, ALBUM, ARTIST, GENRE.
- Binary data (e.g. for album art) is not supported.
- The audio player supports gapless Vorbis playback.

Supported FLAC encoding parameters

- Sampling rates [kHz]: 44.1, 48, 88.2, 96, 176.4, 192
- Resolution [bits]: 16, 24
- Channels: stereo, mono
- The audio player supports reading of FLAC content stored in native FLAC containers. Supported file name extensions: *.flac
- FLAC comments and ID tag support:
 - The audio player supports decoding of FLAC comments.
NOTE: There is no specification for tag names. The system relies on the OSS implementation.

- Tag names decoded: TITLE, ALBUM, ARTIST, GENRE.
NOTE: ID3v2 tags for native FLAC and FLAC containers are out of standard but should be supported if placed at the beginning of a file, see the FLAC-FAQ.
- Gapless FLAC

Supported Uncompressed LPCM , WAV, AIFF encoding parameters

- Sampling rates [kHz]: 44.1, 48, 96, 192
- Resolution [bits]: 16, 24
- Channels: stereo, mono
- Gapless LPCM, WAV, adnd AIFF
- Supported file name extensions: *.wav, *.aiff, *.aif. (AIFF-C not supported)
- The audio player supports extraction of INFO chunks in WAV containers for the following metadata tags: TITLE, ALBUM, ARTIST
- The audio player supports reading of uncompressed LPCM content stored in AIFF containers.
- Support of ID3 chunks in AIFF containers

Supported AAC (AAC-LC /HE-AAC/HE-AAC v2) encoding parameters

- Sampling rates [kHz]: 32, 44.1, 48, 96
- Resolution [bits]: 16
- Bit rate [kbps]: 8, 16, 24, 32, 40, 48, 56, 64, 80, 96, 112, 128, 160, 192
- Channels: stereo, mono
- The audio player supports reading of aac content stored in single stream aac files and mp4 containers. Supported file name extensions: *.aac, *.m4a
NOTE: m4b containers are supported for playback only; bookmarks, chapter markers, hyperlinks, images and other metadata embedded in m4b containers are not supported.
NOTE: Single stream aac files and mp4 containers support ID3 tagging, hence extraction of that metadata is covered by extraction of ID3 tags for mp3 content.
- AAC ID3 tags support
- The audio player supports decoding of ID3v1 and ID3v2 tags in containers
 - The audio player supports decoding of AAC comments.
NOTE: There is no specification for tag names. The system relies on the OSS implementation.
 - Tag names decoded: TITLE, ALBUM, ARTIST, GENRE.
- Gapless AAC: Playback is gapless if the M4A container provides encoder delay and padding information according to iTunes tags, or encoder delay according to Nero tags.

Supported WMA encoding parameters

- Sampling rates [kHz]: 32, 44.1, 48
- Resolution [bits]: 16
- Bit rate [kbps]: 48, 64, 96, 128, 192
- Channels: stereo, mono
- The audio player supports reading of wma content stored in native wma files. Supported file name extensions: *.wma
- The audio player supports extraction of ASF metadata from native wma files.

Supported ALAC encoding parameters

- Sampling rates [kHz]: 44.1, 48, 88.2, 96, 176.4, 192
- Resolution [bits]: 16, 24
- Channels: stereo, mono
- Supported ALAC containers and file extensions
- The audio player supports reading of ALAC content stored in mp4 containers. Supported file name extensions: *.m4a
- ALAC ID3 tags support
- The audio player supports decoding of ALAC comments.
 - NOTE:** There is no specification for tag names. The system relies on the OSS implementation.
- Tag names decoded: TITLE, ALBUM, ARTIST, GENRE.
- Gapless ALAC

NOTE: For correct gapless decoding, the container must provide correct encoder delay metadata (or no encoder delay at all!), which is different from lossy compression formats like AAC.

Follow local guidelines for waste disposal when discarding packaging, electronic appliances, and batteries.

Your Radio is packaged with cardboard, polyethylene, etc., and does not contain any unnecessary materials.

WARNING! This product contains chemicals known to the State of California to cause cancer and birth defects or other reproductive harm.

The user is cautioned that changes or modifications not expressly approved by Sirius XM Radio Inc. can void the user's authority to operate this device.

This device complies with Part 15 of the FCC Rules:

1. This device may not cause harmful interference.
2. This device must accept any interference received, including interference that may cause undesired operation.

NOTE: This equipment has been tested and found to comply with the limits for a Class B digital device, pursuant to Part 15 of the FCC Rules. These limits are designed to provide reasonable protection against harmful interference in a residential installation.

This equipment generates, uses and can radiate Radio frequency energy and, if not installed and used in accordance with the instructions, may cause harmful interference to Radio communications. However, there is no guarantee that interference will not occur in a particular installation. If this equipment does cause harmful interference to Radio or television reception, which can be determined by turning the equipment off and on, the user is encouraged to try to correct the interference by one or more of the following measures:

- To comply with FCC RF exposure compliance requirements, a separation distance of at least 20 cm must be maintained between the antenna of this device and all persons.
- This device must not be co-located or operating in conjunction with any other antenna or transmitter.

End User License Agreement (EULA) Terms and Conditions

(1) End User will have only a non-exclusive, nontransferable license to use the software embedded (Licensed Software) in the GRACE DIGITAL product (Licensed Product), and hence the license is restricted to the scope of the use in the Licensed Product. (2) End User acknowledges that any and all transactions by means of the Licensed Software can only be performed on a certain Cloud Server, which is regulated in the terms and conditions that are laid down in the "Cloud Server terms and conditions" (identified below) which are explicitly accepted by the End User. (3) End User is prohibited from reverse engineering (unless required by law for interoperability), disassembly or decompilation of the Licensed Software and the duplication of the Licensed Software. (4) End User is prohibited from transferring the Licensed Software to another machine. Even if the original Licensed Product is no longer in use, or if the Licensed Software is removed from the original hardware, the EULA is tied to the device on which the Licensed Software is first installed. (5) GRACE DIGITAL disclaims, to the extent permitted by applicable law, any warranty including the implied warranties of satisfactory quality, fitness for a particular purpose, non-infringement and those arising from a course of performance. GRACE DIGITAL does further not warrant that the operation of the Licensed Software will be uninterrupted or error free or that all deficiencies will be corrected. (6) GRACE DIGITAL disclaims any liability for any damages, whether direct, indirect, incidental, or consequential, arising from the use of the Licensed Software. (7) GRACE DIGITAL disclaims liability for the availability and proper functioning of such audio services features, unless it can be demonstrated that GRACE DIGITAL acted willfully or was grossly negligent. (8) The End User acknowledges that the Licensed Software can only be used in conjunction with the Licensed Product and further, that Licensed Software under certain circumstances supports audio services feature, such as Chromecast built-in, which are all subject to the terms of service entered into by the End User and the respective developer, e.g. Google LLC, directly. (9) End User consents that its use of the Licensed Software is audited indirectly by GRACE DIGITAL through the logging of the usage activities of the Cloud Server and that improper use can also be reported to GRACE DIGITAL, and that any audit rights of the Licensor can be assigned to GRACE DIGITAL. (10) The End User is notified that the permission to use the Licensed Software ends with its revocation by GRACE DIGITAL under certain circumstances, which are provided for in "Revocation of the right to use the Licensed Software" (identified below). (11) The End User must acknowledge that the developers of the audio services features, such as Google LLC, may also revoke the license keys to use their feature independently from the EULA and therefore, GRACE DIGITAL cannot intervene in such measures on its own or influence such actions in any other way and cannot be made responsible for the interruption of the services of audio services features, such as Chromecast built-in by the End User. (12) GRACE DIGITAL is designated and accepted expressly as a third party beneficiary due to its intellectual property rights in the Licensed Software of all of the terms of the EULA and End User shall agree that GRACE DIGITAL shall be entitled to enforce its intellectual property rights in the Licensed Software as such under this EULA.

Cloud Server terms and conditions

- (i) The End User acknowledges that the Licensed Software was developed by StreamUnlimited Engineering GmbH (hereinafter referred to as "**SUE**"), and that SUE organizes and supports the cloud server, which is required to access the audio services (the "**Cloud Server**").
- (ii) The End User acknowledges that any use of the Licensed Software and any supported online music feature (e.g. Chromecast built-in) or any other feature may involve a transaction to a Cloud Server, which could be the "Google App Engine", operated and hosted by Google LLC, USA, or any similar operated and hosted by a third party, and therefore SUE is not liable for any unauthorized access to this Cloud Server, and the data processed hereunder.
- (iii) End User may only access the Cloud Server via subscription with the Licensed Product or in a manner otherwise approved by Grace Digital Inc.
- (iv) Upon acceptance of the terms and conditions of the EULA the End User will be granted a non-exclusive, revocable, non-transferable, limited license to use the respective Cloud Server solely for the purpose of streaming content by means of the Licensed Software and the respective online music feature as embedded in the Licensed Product in accordance with the terms and conditions of the EULA.
- (v) End User acknowledges and agrees that it does not have, nor will it claim any right, title or interest in the Cloud Server, data, applications, methods of doing business or any elements thereof, or any content processed on the Cloud Server.

- (vi) The license of the End User to use the Cloud Server terminates with the abandonment of the ownership in the Licensed Product.

Data Processing for activation and auditing purpose

- (vii) End User acknowledges that SUE is entitled to audit the proper use of the Licensed Software by the End User, in order to detect any illegal or otherwise irregular use of the Licensed Software (e.g. transfer of a copy of the Licensed Software to a non-licensed device), with appropriate means.
- (viii) The Licensed Product may communicate with the Cloud Server during any operation, which generates certain data that are used to authenticate and to audit the legitimate use of the Licensed Software by SUE. This data processing is a feature, which does not infringe the interests of the End User in secrecy deserving protection, because SUE can invoke on its legitimate prevailing interests as owner of the intellectual property rights in the Licensed Software to audit the proper use.
- (ix) Hence, End User acknowledges that the usage of the Licensed Software is monitored by SUE in a way that any operation by using the Licensed Product is logged by SUE by means of processing the product MAC addresses, the IP Address of the End User, the brand name, model name and firmware version of the Licensed Product, the Token (if applicable) and a timestamp regarding the transactions upon each access to the Cloud Server. By analyzing these data SUE can detect any misuse of the Licensed Software. The End User further acknowledges that SUE may store and process any data from such monitoring activities, analyze this data in the case of a strong suspicion of unlawful misuse of Licensed Software and also transmit the data in a non-personal related format to the respective developers of any supported features, provided that the suspicion of infringement by the End User is substantiated.

I) Revocation of the right to use the Licensed Software

- (x) The End User acknowledges that the right to use the Licensed Software can be revoked by SUE, if the analysis of the monitored data indicates a strong suspicion of unlawful misuse of the Licensed Software, and that he receives an automated notification with the instruction to contact Grace Digital customer support. If the End User turns out to be the legitimate one, the customer support can enable again the Licensed Product for the End User.
- (xi) The End User accepts that SUE is third party beneficiary of the EULA due to its intellectual property rights in the Licensed Software with regard to the use of the Licensed Software and can, therefore, defend the rights in the Licensed Software as well as enforce any rights and claims from a misuse of the Licensed Software or an infringement of the EULA directly against the End User.

Grace Radio Station List

End User acknowledges that when using the Grace radio station list that the Grace servers identifies the user's radio by means of processing the product MAC addresses, and a timestamp regarding the transactions I order to provide the radio the list of stations list. The End User acknowledges that Grace Digital may store and process any data from such communications activities in order to provide service to the user's radios.

The Grace Radio stations list is maintained by Grace and some independent partners. We do not warrant or guarantee the access to a specific radio station for the life of the product as Grace Digital cannot control the radio station's desire to be in the database or for a station's ability to continue operations.

Other Third Party Service Providers

End User acknowledges that when using other 3rd party service providers on the Grace radios that those individual service providers may track the radio's interaction with their 3rd party service. The End User acknowledges that Grace Digital does not manage, control or track usage of the radios when the end user is using 3rd party service providers. Additionally, while Grace Digital will do their best to ensure that each service is available on the Grace radio for the life of the product, Grace Digital cannot control nor is it connected to any service provider. Grace Digital cannot guarantee that service providers will continue to operate, or continue to make their service available on this device under the current terms offered by the various 3rd party service providers.

Important Notice: Required Subscription

Hardware and subscription sold separately, and activation fee required. Other fees and taxes may apply.

Subscriptions governed by SiriusXM Customer Agreement; see www.siriusxm.com. Service automatically renews into the subscription Package you choose (which may differ from the Package which arrived with the Radio), for additional periods of the same length, and automatically bills at then-current rates, after any complimentary trial or promotional period ends. You must call us to cancel at 1-866-635-2349. Fees and programming are subject to change.

© 2021 Grace Digital Inc. "Sirius", "XM" and all related marks and logos are trademarks of Sirius XM Radio Inc. and its subsidiaries. All other marks and logos are the property of their respective owners. All rights reserved. Certain features depend on subscription package.

Limited Manufacturer's Warranty

- Your Internet radio is supported by a limited manufacturer's warranty for product defects in material or workmanship that may be evident under normal use for 1 year from date of purchase from an authorized franchisee or dealer.
- The warranty stated herein is the only warranty applicable to this product. All other warranties, expressed or implied are hereby disclaimed and are limited by the written limited warranties contained herein. Except as provided herein, the manufacturer shall have no liability or responsibility to a customer or any other person or entity with respect to any liability, loss or damage caused directly or indirectly by use or performance of the product or arising out of any breach of this warranty, including, but not limited to, any damages resulting in inconvenience, loss of time, data, property, or profit or any indirect, special, incidental, or consequential damages, even if the manufacturer has been advised of the possibility of such damages.
- In the event of a product defect during the warranty period, return of the product and your sales receipt as proof of purchase date for your unit is required and shall, at the discretions of the manufacturer, result in: (a) correction of the defect by repair without charge for parts and labor; (b) replacement with the same or similar design; or (c) refund for the purchase price if purchased directly and returned within 30 days of purchase. All replaced parts / products, on which a refund may be made, become the property of the manufacturer. New or reconditioned parts / products should be warranted for the remainder of the original warranty period.
- The warranty does not cover: (a) damage or failure caused by or attributed to acts of God, abuse, accident, misuse, improper installation or improper maintenance, alteration, lightning or excessive voltage or current; (b) any repairs other than those provided by Grace Digital; (c) consumables such as fuses or batteries; (d) cosmetic damage; (e) transportation, shipping or insurance costs; (f) costs of product removal, installation, set-up, service adjustment or re-installation.
- Customers are responsible for any shipping costs related to product return, Grace Digital will pay for shipping of the refurbished or replacement radio to the customer to the contiguous United States. All other shipping charges are the customer's responsibility.

**Grace Digital Inc.
11895 Community Road
Poway, CA 92064**

gracedigital.com

support.gracedigital.com | 1.800.903.9524 | support@gracedigital.com