



EcoTrek

Models: GDI-EXTRK200...210

User Guide



IMPORTANT SAFETY INFORMATION

WARNING: TO REDUCE THE RISK OF ELECTRIC SHOCK, DO NOT DISASSEMBLE AS THERE ARE NO USER-SERVICEABLE PARTS INSIDE. REFER SERVICING TO QUALIFIED SERVICE PERSONNEL.



The lightning flash with arrowhead symbol, within an equilateral triangle, is intended to alert the user to the presence of non-insulated "dangerous voltage" within the product's enclosure that may be of sufficient magnitude to constitute a risk of electric shock.



The exclamation point within an equilateral triangle is intended to alert the user to the presence of important operating and maintenance instructions in the literature accompanying the appliance.

IMPORTANT SAFETY INSTRUCTIONS

1. Read these instructions - All the safety and operating instructions should be read before this product is operated.
2. Keep these instructions - The safety and operating instructions should be retained for future reference.
3. Heed all warnings - All warnings on the appliance and in the operating instructions should be adhered to.
4. Follow all instructions - All operating and use instructions should be followed.
5. This apparatus can be used in outdoor conditions after disconnected the AC Mains supply and closing the waterproof cap for the AC inlet. It must not be used in outdoor conditions when charging. Do not use this apparatus near water - The appliance should not be used near water or moisture - for example, in a wet basement or near a swimming pool, and the like'
6. Clean only with dry cloth.
7. Do not block any ventilation openings. Install in accordance with the manufacturer's instructions.
8. Do not install near any heat sources such as radiators, heat registers, stoves, or other apparatus (including amplifiers) that produce heat.
9. Only use attachments/accessories specified by the manufacturer.



10. Use only with the cart, stand, tripod, bracket, or table specified by the manufacturer, or sold with the apparatus. When a cart or rack is used, use caution when moving the cart/apparatus combination to avoid injury from tip-over.

11. Do not install this equipment in a confined or building-in space such as a book case or similar unit, and remain a well ventilation conditions. The ventilation should not be impeded by covering the ventilation openings with items such as newspaper, table-cloths, curtains etc.
12. Protect the power cord from being walked on or pinched particularly at plugs, convenience receptacles, and the point where they exit from the apparatus.
13. Unplug this apparatus during lightning storms or when unused for long periods of time.
14. CAUTION: Danger of explosion if battery is incorrectly replaced. Replace only with the same or equivalent type.
15. The battery (battery or batteries of battery pack) shall not be exposed to excessive heat such as sunshine, fire or the like.

16. Refer all servicing to qualified service personnel. Servicing is required when the apparatus has been damaged in any way, such as power-supply cord or plug is damaged, liquid has been spilled or objects have fallen into the apparatus, the apparatus has been exposed to rain or moisture, does not operate normally, or has been dropped.
17. Keep a minimum distance of 5cm around all edges of the display for sufficient ventilation.
18. The ventilation should not be impeded by covering the ventilation openings with items, such as newspapers, table-cloths, curtains, etc.
19. No naked flame sources, such as lighted candles, should be placed on the apparatus.
20. Operating Environment: temperature: 5 degree-35 degree, Humidity: 10% to 90% non-condensing, altitude: 0-2000m. Safety way to remove the battery or the battery from the equipment: Remove the old battery or battery pack, follow the steps in reverse order than the assembly. To prevent contamination of the environment and bring on possible threat to human and animal health, the old battery or the battery put it in the appropriate container at designated collection points. Do not dispose of batteries or battery together with other waste. It is recommended that you use local, free reimbursement systems batteries and accumulators. The battery shall not be exposed to excessive heat such as sunshine, fire or the like. Do not remove battery incorporated with product for your safety. If you need to replace the battery, take it to the nearest authorized EcoTrek service point or dealer for assistance.

Safety way to remove the battery or the battery from the equipment: Remove the old battery or battery pack, follow the steps in reverse order than the assembly. To prevent contamination of the environment and bring on possible threat to human and animal health, the old battery or the battery put it in the appropriate container at designated collection points. Do not dispose of batteries or battery together with other waste. It is recommended that you use local, free reimbursement systems batteries and accumulators. The battery shall not be exposed to excessive heat such as sunshine, fire or the like. Do not remove battery incorporated with product for your safety. If you need to replace the battery, take it to the nearest authorized EcoTrek service point or dealer for assistance.



Correct Disposal of this product. This marking indicates that this product should not be disposed with other household wastes throughout the EU. To prevent possible harm to the environment or human health from uncontrolled waste disposal, recycle it responsibly to promote the sustainable reuse of material resources. To return your used device, please use the return and collection systems or contact the retailer where the product was purchased. They can take this product for environmental safe recycling. WEEE directive

Rating Label

The product rating label is located on the battery cover.

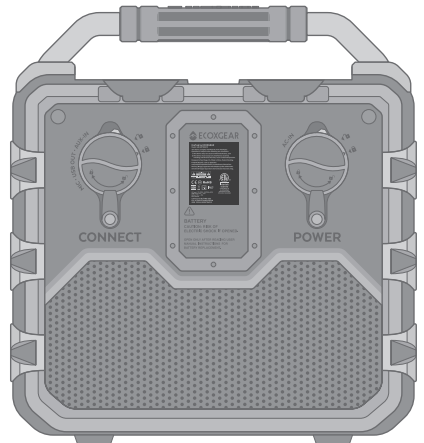

EcoTrek Layout

Rugged Carrying Handle

Control Panel

Built-In Speakerphone Mic Location

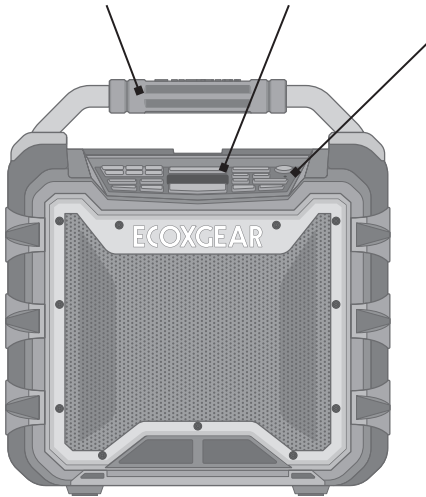

FRONT

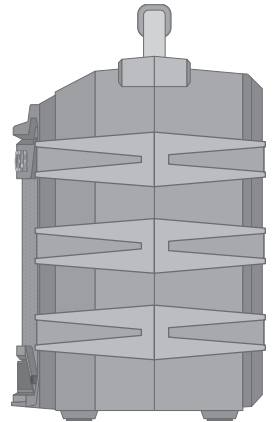

RIGHT SIDE

Connections

Battery Compartment

Power

Subwoofer

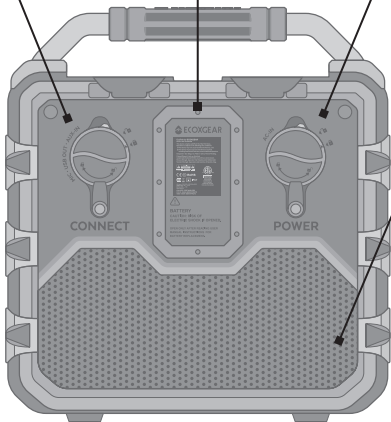

BACK

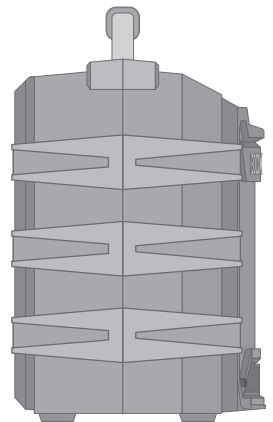



LEFT SIDE

Important: Maintaining Waterproofness

If the caps on the back are not properly closed, the unit is **NOT** watertight.

Waterproof Caps

To close properly, turn the cap clockwise so the cap's arrow point lines up with the locked symbol .

To access the connections, turn the cap counterclockwise so the cap's arrow point lines up with the unlocked symbol , then pull the tab on the cap to open.

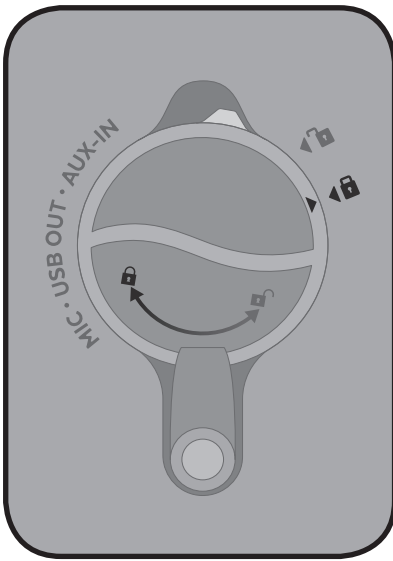

LOCK

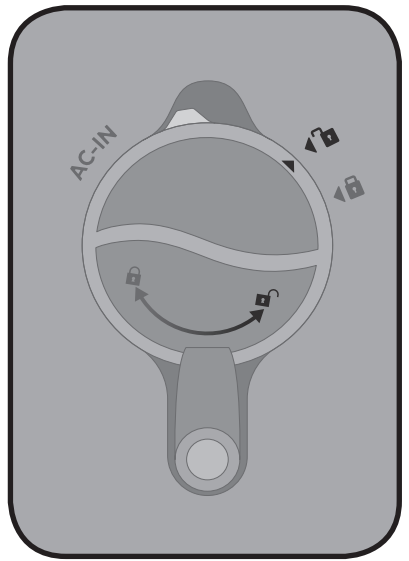

UNLOCK

Connect + Power

In/Out Connections

Do **NOT** use these connections if they are wet.

Microphone Jack: You can input a microphone, guitar, or other musical instrument. Port is ¼" (6.35 mm). (Dynamic Mic Only).

AUX Jack: This input can be used to connect a CD player, MP3 player, etc.

USB Jack: Connect your device's charge cable here to charge it. USB charging only functions when the EcoTrek's power is turned on. USB port rating is 5V, 2.1A.

Power

Do **NOT** plug unit into wall power outlet if power cable jack is wet. If water has entered the unit, do **NOT** attempt to charge the EcoTrek; instead, please contact Grace Digital at www.gracesupport.com.

Use Caution: 120V AC Power Input. Contact may cause electric shock and injury if wet.

Insert the included power cable to charge the EcoTrek.

Note: The EcoTrek can be played while battery charges.

The  icon will be on when plugged into AC power. When the power cable is connected, blinking of the battery segments shows the battery is charging. When fully charged, all battery segments will be lit without blinking. It can take 4 to 8 hours to fully recharge the battery from empty.

Notes:

- Fully charge prior to first use (4-8 hours).
- Fully charge prior to extended storage (4-8 hours).
- Store unplugged, but fully recharge every 3 months (4-8 hours).
- Do **NOT** leave a unit plugged in and charging continuously for more than 8 hours after the unit indicates a full charge.
- Follow provided instruction when attempting to replace battery. (If needed, contact Grace Digital at www.gracesupport.com).
- Avoid completely draining the battery.
- Avoid storing in high temperatures and moist places.
- For long-term storage, periodically recharge the battery.
- If you do not charge the battery for six months, it may not charge.

Microphone Jack

Power Cable Jack

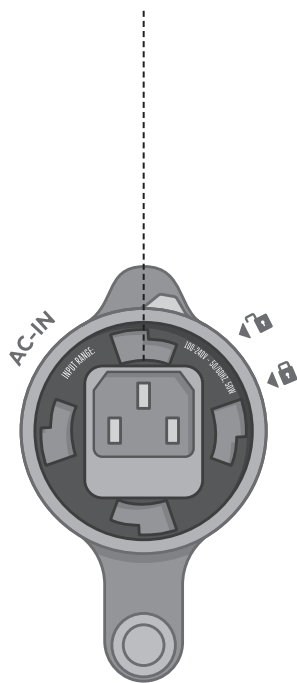
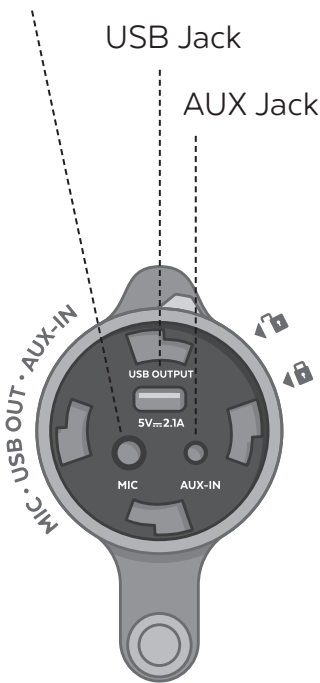

CONNECT

POWER

Display + Controls

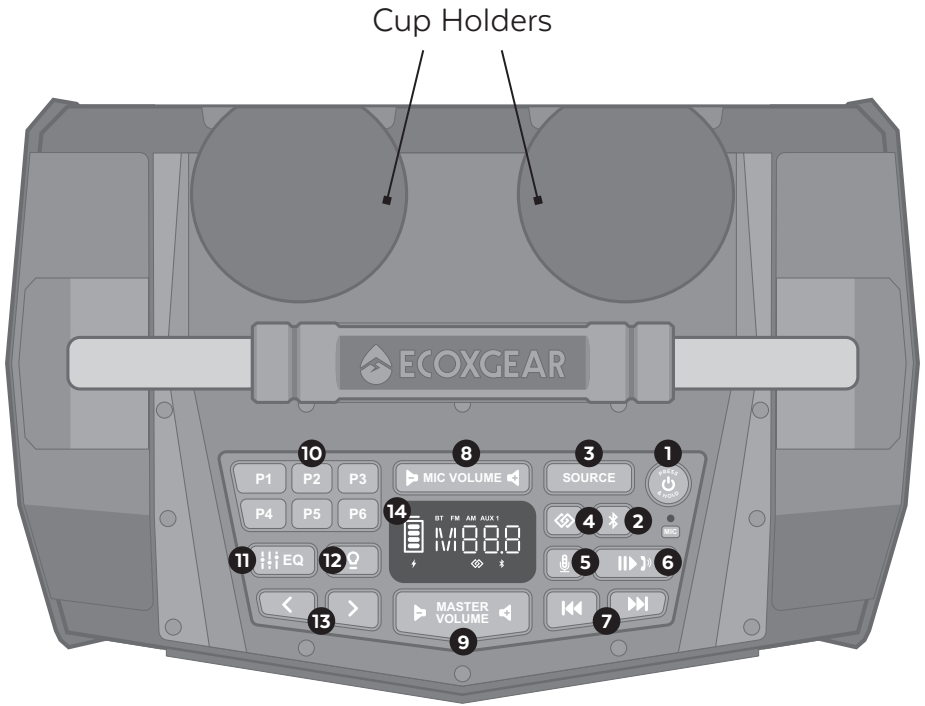

TOP

- 1. Power Button:** Turns EcoTrek on or off. Press and hold for 3 seconds.
- 2. Bluetooth Button:** When in Bluetooth mode, if the Bluetooth icon is not flashing on the LED screen, press this button to enter pairing mode. If your device is paired (solid icon on LED screen), press button to disconnect. Press and hold this button for 5 seconds to clear all pairing records.
- 3. Source Button:** Press this button to cycle through the following modes: Bluetooth, FM, AM, and AUX.
- 4. EcoConnect Button:** If you have purchased a second EcoTrek (or one other ECOXGEAR speaker bearing the EcoConnect symbol), press and release this button on both speakers to link them together and play in stereo.
- 5. EcoTalk:** This button activates your Voice Assistant (Siri and OK Google).
- 6. Play/Pause:** Press to play or pause a track from a paired Bluetooth device.
- 7. Track Buttons:** Press these buttons to go to the previous/next track on a paired Bluetooth device.

8. **Microphone Volume Control:** Press to adjust the microphone volume. Press and hold to adjust the volume continually (volume levels are 0 to 30).
9. **Master Volume Control:** Press to adjust the speaker's main mix volume. Press and hold to adjust the volume continually (volume levels are 0 to 30).
10. **AM/FM Presets:** Store up to 6 of your favorite AM/FM radio stations and quickly tune to a preset radio station.
11. **Equalization:** Press the EQ button to activate the Preset EQ modes.
12. **Backlight Button:** Press to turn button backlights on / off.
13. **Tune Buttons:** Press these buttons to tune in a radio station. To "seek" (jump to the next available station), press and hold either button down for a few seconds until it starts to seek a station.
14. **LED Screen Icons:**



Indicates the battery level of the EcoTrek.



Indicates the AC power is plugged in.



When the battery level is less than 20%, the first bar will blink.



Two speakers are paired via EcoConnect.



Indicates that the battery level is very low.



In pairing mode, the icon will flash. If the connection is successful, the icon will be solid.

BT

The EcoTrek is in the Bluetooth mode.

V L 0 7

Indicates the speaker volume level of EcoTrek. (0 to 30)

FM

The EcoTrek is in FM mode.

M L 1 5

Indicates the microphone vol. level of EcoTrek. (0 to 30)

AM

The EcoTrek is in AM mode.

^{FM} 99.6

Indicates the current FM station of the EcoTrek.

AUX 1

The EcoTrek is in AUX mode.

^{AM} 520

Indicates the current AM station of the EcoTrek.

Operations



Power On/Off

Power On: **PRESS AND HOLD**  for 3 seconds to power on the EcoTrek. “Speaker on, ready to connect” voice prompt will be heard.

Power Off: **PRESS AND HOLD**  for 3 seconds to power off the EcoTrek.

Inactivity Auto-Power off: If either no music is played while it is in Bluetooth mode or if an Aux In cable is not plugged in while it is in AUX mode for 30 minutes, the EcoTrek will automatically power off to save power. Your EcoTrek will not automatically power off after 30 minutes of inactivity if it is plugged into an AC outlet.









Pairing a Bluetooth Device

1. Turn on your Bluetooth device.
2. Power on EcoTrek. “Speaker on, ready to connect” voice prompt will be heard. If already powered on and not in Bluetooth mode, press **SOURCE** until it is in Bluetooth mode. (If Bluetooth icon on LED screen is not flashing, briefly press  to start pairing your device.)
3. Navigate to your Bluetooth device’s setup screen, find ECOXGEAR and connect. If the connection is successful, the Bluetooth icon will be lit solid and your EcoTrek will announce “Connection successful.”









Notes:

- If the pairing is not complete within 5 minutes, the speaker will exit the pairing mode. You need to repeat the pairing steps again.
- After the connection is successful, if you turn the speaker off and turn it on again, it will reconnect to the last connected device automatically. Also, a voice prompt “Speaker on, ready to connect” followed by “Connection successful” will be heard.
- Press and hold  for 5 seconds to clear all pairing records.

Adjust the Master Volume

1. Press  **MASTER VOLUME**  briefly to adjust the speaker volume.
2. Press and hold  **MASTER VOLUME**  to adjust the speaker volume continuously (volume levels are 0 to 30).
 - a. Press  briefly to increase one volume level. Press and hold  to keep increasing the volume until maximum volume level is reached.
 - b. Press  briefly to decrease one volume level. Press and hold  to keep decreasing the volume until minimum volume level is reached.

Adjust the Microphone Volume

1. Press  **MIC VOLUME**  briefly to adjust the microphone volume.
2. Press and hold  **MIC VOLUME**  to adjust the microphone volume continuously (volume levels are 0 to 30).
 - a. Press  briefly to increase one volume level. Press and hold  to keep increasing the volume until maximum volume level is reached.
 - b. Press  briefly to decrease one volume level. Press and hold  to keep decreasing the volume until minimum volume level is reached.

Notes:

- This function only adjusts the external microphone input jack.
- The internal microphone used for EcoTalk (the activation of voice assistants, such as Siri and OK Google, on your device), and phone calls is not independently adjustable from the Master Volume.

Source Button

Press **SOURCE** briefly to cycle through the following modes: BT (Bluetooth), FM, AM, AUX 1.

Play Music (Bluetooth Mode)

After the EcoTrek is connected to your Bluetooth device, press  briefly on the EcoTrek to play, press  again to pause.

Press  briefly to play previous song. Press  briefly to get the next song.

Press  **MASTER VOLUME**  to adjust the volume.

Notes:

- Pair and connect your Bluetooth device with EcoTrek before using this feature.
- If a call is received when you are listening to music, the music will pause automatically.
- You can also control Volume and Play / Pause music operations from your Bluetooth enabled device.



EcoTalk

Press the EcoTalk button  to activate the voice assistant on your device (Siri, OK Google, etc.). Once activated, the speakerphone mic on your EcoTrek will hear your voice commands and transfer them to the voice assistant on your device.

Notes:

- Before using the EcoTalk function, your device must be connected to the EcoTrek via Bluetooth.
- Not all devices have voice assistant functionality; refer to your device for details.

Listening (AM/FM Mode)

Press **SOURCE** briefly to switch to FM or AM. Press   to tune in a radio station. To “seek” (jump to the next available station), press and hold either button down for a few seconds until it starts to seek a station.

Press  **MASTER VOLUME**  to adjust the volume.

AM/FM audio cannot be sent between two speakers via the EcoConnect feature. Only Bluetooth audio works with EcoConnect.

AM/FM Presets



Store a favorite radio station to quickly tune to a preset radio station. There are 6 positions for AM station and 6 positions for FM stations. While listening to a station you want to store, press and hold a preset button (P1-P6) to assign the current station to that preset number. The LED screen will flash 2 times to indicate it has been set.

If you want to listen to a stored preset, press a preset button (P1-P6) to go to the stored radio station.





Equalization

Press the EQ button once to activate the Preset EQ modes. Use the Tune buttons to cycle through the five modes: Normal, Classical, Pop, Jazz, and Rock.

After six seconds of inactivity, the EcoTrek will automatically exit the EQ Input screen; the EQ button must be pressed again to change modes.

Note: The EcoTrek will automatically save your EQ settings even after powering the speaker off.

LED Screen: Preset EQ Modes

	Normal: the default setting for best overall performance.		Jazz: mainly increases the high frequencies.
	Rock: increases volume level; may cause distortion on some songs.		Classical: increases bass performance.
	Pop: increases both midrange and high frequencies.		

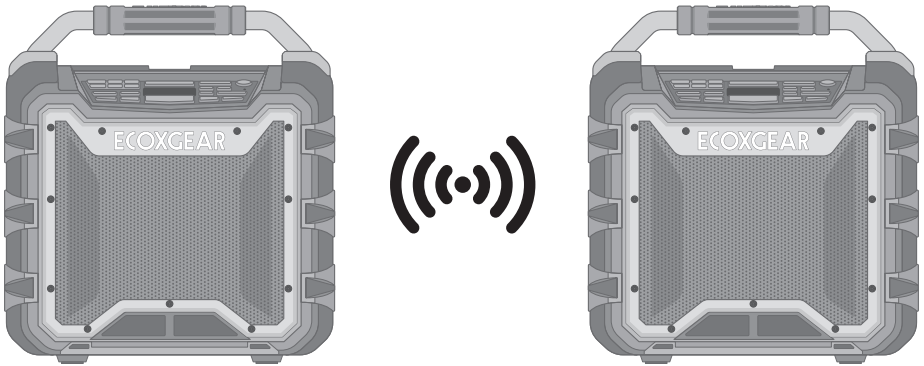

EcoConnect - Wireless Stereo Connection of Two Speakers



When you have two EcoTrek speakers and want to wirelessly pair them for stereo sound, first follow the **Pairing a Bluetooth Device** instructions to connect one EcoTrek speaker to your Bluetooth device. Leave this EcoTrek speaker powered on and connected to your device.

Next, place the two EcoTrek speakers next to each other and turn on your second EcoTrek speaker. Once the second speaker is powered on (the Bluetooth light will be flashing), press the EcoConnect Button  on both of your EcoTrek speakers. Wait a few seconds for the speakers to wirelessly connect. Both speakers will announce "Connection Successful," and the EcoConnect icon on the LED screen on both units will light up once the connection is completed.

Once the two EcoTrek speakers are connected via EcoConnect, start playing music from your device. Both connected EcoTrek units will play the music from you device.

The EcoConnect default has your speakers playing in stereo mode. If you would like to change which speaker is left or right or if you want to set each speaker to play in mono mode you can press and hold . Each press and hold of  will change the speaker from RIGHT / LEFT to LEFT / RIGHT to MONO. When changing modes, the left and right speakers will announce, "Stereo mode, left speaker," "Right

speaker," respectively. When in mono mode, both speakers will announce, "Mono mode."

The EcoConnect connection between the two EcoTrek speakers will **NOT** automatically re-connect after the speakers are turned off. To re-establish EcoConnect between the speakers, after power off, please follow the above steps.

Notes:

- You can also pair the EcoTrek with any other ECOXGEAR speaker bearing the EcoConnect symbol  .
- The EcoConnect functionality is only available while using Bluetooth as your audio source at a maximum range of 30 feet between both of the paired speakers.
- While pairing the two EcoTrek speakers, make sure that the speakers are within a few feet of each other.

Battery Care + Replacement

Optimizing Battery Life

As with a car battery, proper use and treatment of your speaker's rechargeable, lead-acid battery can help it last for years.

Battery Usage:

- Fully charge the EcoTrek prior to first use (4-8 hours).
- Completely charge the battery after each use.
- Avoid completely draining the battery.
- Do **NOT** leave your fully-charged speaker plugged in when it is not in use.

Battery Storage:

- Fully charge the EcoTrek prior to extended storage (4-8 hours).
- Do **NOT** leave your speaker plugged in while it is in storage.
- Avoid storing in high temperatures and moist places.
- For long-term storage, fully recharge the battery every 3 months.
- If you do not charge the battery within six months, it may not charge.

Battery Disposal:

- Bring the battery to a recycling center or dispose of in accordance with local ordinances.
- Contact Grace Digital at www.gracesupport.com for assistance with disposing your old battery.

Battery Replacement

For a complete demonstration of replacing the battery, see our video on www.ecoxgear.com.

- 1. IMPORTANT:** Disconnect all power cables. Make sure that the EcoTrek is disconnected from any electrical power outlets. If EcoTrek is on, press and hold the power button to turn it off.
2. Remove the battery door by unscrewing the (8) screws. This will require a Phillips screwdriver.
3. With the battery door removed, the battery will be visible. It is fit snugly into the unit and surrounded by foam strips.
4. To remove the battery, tilt the EcoTrek backward so that the open battery cavity is facing the ground.
5. Lift the EcoTrek unit slightly and gently tap the unit on the ground on the bottom-back edge of the unit and gravity should cause the battery to start to slip out slowly. Once the battery has moved out some, use your hands to gently pull the battery from the cavity.

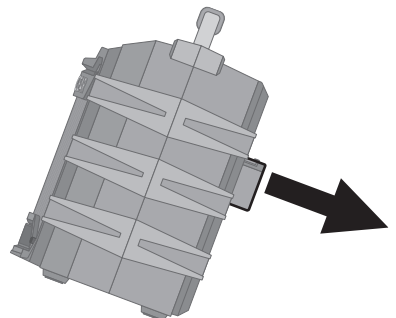
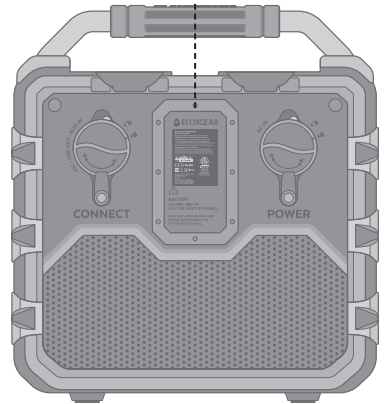
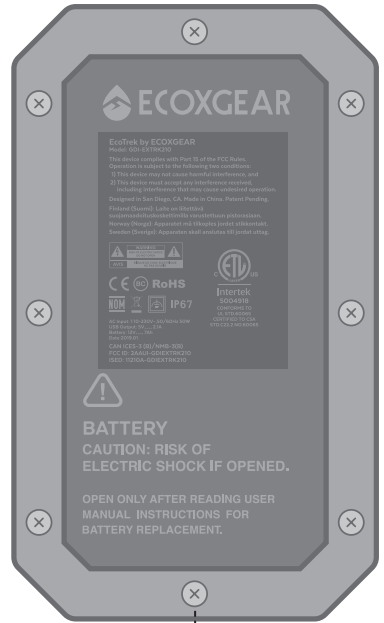

6. Once the battery has been removed from the cavity, first slide the metal connector on the end of the **BLACK** wire off of the **BLACK**, negative terminal, then the metal connector on the end of the **RED** wire off of the **RED**, positive terminal. This will completely disconnect the battery from the EcoTrek unit.

IMPORTANT: Note how the terminals on the battery are connected. The **RED** wire to the **RED**, positive terminal. The **BLACK** wire to the **BLACK**, negative terminal. The replacement battery **MUST** be connected the same way.

7. Attach the wires to the replacement battery the same way they were connected to the original battery. First connect the **RED** wire to the **RED**, positive terminal, then the **BLACK** wire to the **BLACK**, negative terminal. (Only use an approved replacement battery that meets the specifications provided by ECOXGEAR. For more specifics or further information, contact ECOXGEAR customer support.) Unit will not work correctly and may be damaged if wires are not correctly attached.

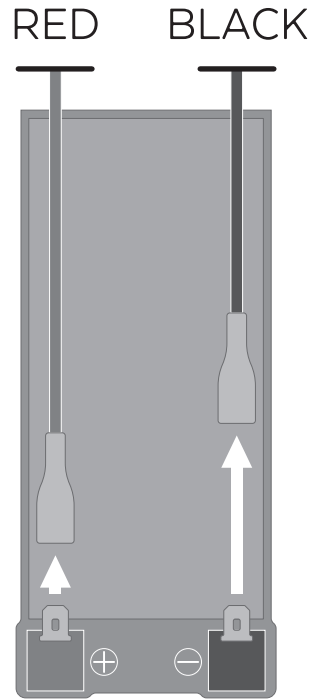

BATTERY TOP

8. If you purchase your own battery, make sure to also apply adhesive foam pads on the left and right side of the battery. (You may be able to peel off the foam strips from the original battery. If not, you can also purchase adhesive pads of similar material and thickness.) These pads ensure that the replacement battery is securely fastened and will not move within the battery cavity.
9. Slide the new battery, with the terminals at the top, into the cavity and gently push until the battery is flush with the back of the EcoTrek.
10. Replace the battery door and re-insert the screws.
11. Check if the battery door is securely fastened to the speaker housing. A loose battery door may compromise speaker waterproofness.
12. Power on the EcoTrek to ensure proper function. Be sure to fully charge the new battery prior to use (4-8 hours).

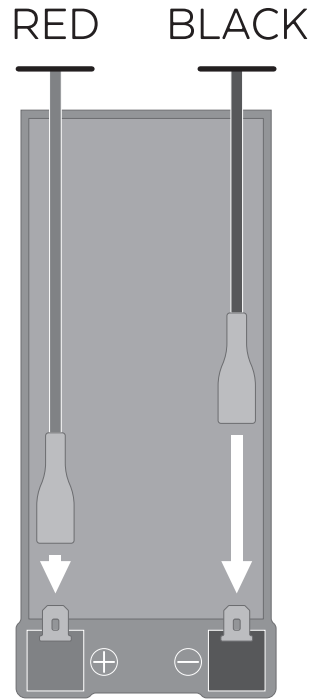

NEW BATTERY
TOP

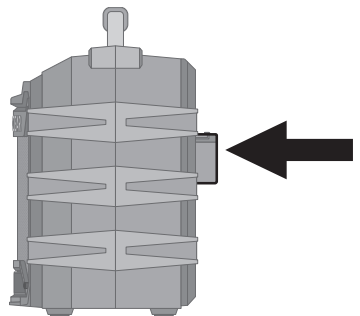

Troubleshooting

The sound is distorted

Try lowering the volume control of your connected device or musical instrument. Also, try to reduce the overall volume of the EcoTrek.

Cannot Pair With Bluetooth Device

Make sure that your device is compatible with Bluetooth. Turn off your EcoTrek and Bluetooth device, then power on and reconnect. Make sure that Bluetooth mode is selected on your EcoTrek.

There is a high-pitched whistling noise when using microphone

This is probably feedback. Point the microphone away from the speaker.

If there is poor AM/FM reception

To adjust AM/FM reception, move entire product.

Can NOT play music from a flash drive

The USB ports are only for charging USB devices.

Volume level is too low

Increase the volume on the EcoTrek and / or increase the volume on your Bluetooth device.

Battery not properly charging

Twenty minutes after plugging into an AC power outlet, EcoTrek will check if the battery is rechargeable. If not, the individual bars on the battery level indicator on the LED screen will flash from top to bottom. (Normally, the battery segments will flash from bottom to top.) Please do **NOT** attempt to fix your EcoTrek unit. Please contact our Customer Support at support@gracedigital.com or call us at **800.903.9524**.

Specifications

Dimensions

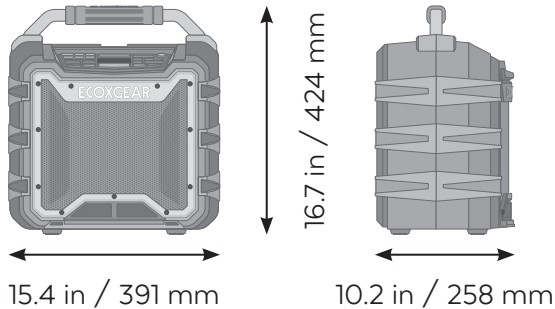

Bluetooth Compliance

Bluetooth V 4.2

Bluetooth Frequency Band

2.402-2.480GHz ISM Spectrum

Modulation

GFSK, $\pi/4$ -DQPSK, 8DPSK

Bluetooth Range

Up to 100 ft / 30m

Tweeter

2x 2.5" (63.5mm) tweeter

Passive Woofer

2x 5.25" (133.35mm) woofer

Woofer

2x 5.25" (133.35mm)

full range woofer

Audio Output Power

100 W (peak)

Power Source

12V, 7.0Ah SLA Battery

Power Supply

Input voltage: 110-230V~50/60Hz

USB Output

5V, 2.1A

Charging Time

Approximately 8 hours

EcoConnect

TrueWireless Stereo (TWS)

EcoConnect Range

30 ft / 9.1 m between
left and right speaker

Compatibility

Mobile phone/device supporting
Bluetooth V1.1 (and above)

Radio Frequency Range

US: AM 520 - 1710 kHz,
FM 87.5 - 107.9 MHz

Fuse

Glass tube (slow-blow)
Ø 5.2x20mm; 250V, 1A

Storage Temperature

-40°F to 122°F / -40°C to 50°C

Operating Temperature

23°F to 95°F / -5°C to 35°C

Waterproof / Dust Rating

IP67

Play Time

Up to 100 hrs in standby, 50hrs play
time, 10hrs play time at max. volume

FCC STATEMENT:

This device complies with Part 15 of the FCC Rules. Operation is subject to the following two conditions:

- 1.) This device may not cause harmful interference, and
- 2.) This device must accept any interference received, including interference that may cause undesired operation.

WARNING: Changes or modifications not expressly approved by the party responsible for compliance could void the user's authority to operate the equipment.

NOTE: To maintain compliance with FCC's RF Exposure guidelines, this equipment should be installed and operated with minimum distance between 20cm the radiator to your body: Use only the supplied antenna. FCC ID: 2AAUI-GDIEXBLD801.

This equipment has been tested and found to comply with the limits for a Class B digital device, pursuant to Part 15 of the FCC Rules. These limits are designed to provide reasonable protection against harmful interference in a residential installation. This equipment generates, uses, and can radiate radio frequency energy and, if not installed and used in accordance with the instructions, may cause harmful interference to radio communications. However, there is no guarantee that interference will not occur in a particular installation. If this equipment does cause harmful interference to radio or television reception, which can be determined by turning the equipment off and on, the user is encouraged to try to correct the interference by one or more of the following measures: reorient or relocate the receiving antenna, increase the separation between the equipment and receiver, connect the equipment into an outlet on a circuit different from that to which the receiver is connected, consult the dealer or an experienced radio/TV technician for help.

RF WARNING STATEMENT:

The device has been evaluated to meet general RF exposure requirement. The device can be used in portable exposure condition without restriction.

IC STATEMENT:

This device complies with Industry Canada licence-exempt RSS standard(s). Operation is subject to the following two conditions:

- 1.) This device may not cause interference, and
- 2.) This device must accept any interference, including interference that may cause undesired operation of the device.

PRODUCT USE AND PROTECTION:

Read and follow all instructions. Use only as intended.

The ECOXGEAR Bluetooth speaker is intended to be used indoors or outdoors and in land or water environments. The speaker has been tested to IP67 waterproofing standards, which means the speaker can be submerged in up to 3 feet of water for 30 minutes without any damage. However, the speaker is **NOT** intended for constant underwater use.

Always make sure the cap(s) / cover(s) are clean, free from sand or debris, and correctly fitted. The speaker will only meet IP67 ratings if all rubber seals, gasket(s) and cover(s) / cap(s) are in place. If you notice a muffling of audio after submersion, gently shake the unit to clear excess water. If your speaker is exposed to salt water, clean it thoroughly after use with fresh water.

The power cable and the unit with an improperly fitted cap are **NOT** waterproof.

To prevent fire or shock, do **NOT** attempt to charge this unit if it is wet or you suspect water has entered the unit. In this situation, please return the unit to Grace Digital for a free assessment. If we have found that the unit has carried water, we will repair or replace the unit free of charge.

SAFETY ADVISORY & WARNING:

Read and follow all instructions. Use only as intended.

CAUTION: Do **NOT** open to repair. A qualified technician must carry out repair work.

ATTENTION: Do **NOT** charge while the unit is wet. Towel dry the unit **AND** make sure all connections are dry **BEFORE** plugging in the charging connector. Failure to do so may result in electrical damage to the unit and may void the warranty.

⚠ WARNING: Cancer and Reproductive Harm - www.P65Warnings.ca.gov

WARNING: Danger of explosion if battery is incorrectly replaced.

CAUTION: The unit can be used with the main power cord disconnected, the unit is readily operable with the main power cord disconnected.

ATTENTION: Do **NOT** dispose of in a landfill. Contact Grace Digital at www.gracesupport.com or a certified recycling agent to dispose of the unit.

SAFETY:

This product has a limited life span of use and should be replaced when it shows obvious signs of wear.

Do not modify or remove any original component parts of the speaker. Doing so could cause damage to the unit, allowing water to ingress. A unit with water ingress should not be charged due to potential risk of fire or shock.

Please exercise care and good judgment when using your ECOXGEAR speaker. Audio levels should be appropriate to your environment, comply with all local regulations, and always ensure that you can hear and be aware of any potential hazards around you.

You should always

- 1.) Use the ECOXGEAR speaker in accordance with any music or noise rules and regulations.
- 2.) Properly seal the ECOXGEAR prior and after each use when in humid or water environments to avoid water damage to the internal components. Salt water / air is particularly corrosive. Always make sure that the gaskets are sealed when in a salt water environment and that the unit is properly rinsed off after use.
- 3.) Properly clean the ECOXGEAR and ensure the gaskets have no sand, dirt, or water on them prior to storage.
- 4.) Store your unit with all caps properly sealed to avoid long term internal moisture damage inside your unit.
- 5.) Completely dry and clean your ECOXGEAR prior to attempting to charge the unit.
- 6.) Return the ECOXGEAR to Grace Digital if you suspect water ingress into the unit or if the unit has experienced a severe impact that may have affected the integrity of the unit to take on water.

You should never

- 1.) Never charge your ECOXGEAR if you suspect water has entered the device. Charging a device with water inside could be potentially hazardous and cause fire or a spark.
- 2.) Never use your ECOXGEAR if you have dropped it or thrown it against a hard surface which may have destroyed the integrity of the speaker, housing, or gaskets. In the event of a severe impact to your unit, please return the unit to Grace Digital to review for potential damage.
- 3.) Never open the auxiliary doors in a water environment. This could cause water to ingress into the unit which could potentially be hazardous and cause a fire or a spark.
- 4.) Never connect a device to the auxiliary input jacks when in a water environment. The auxiliary jacks should only be used in a dry environment.
- 5.) Never attempt to fix, repair your ECOXGEAR unit. Please send it back to Grace Digital for any assessments and repairs.

CARE, MAINTENANCE & PRECAUTIONS:

- 1.) The unit is waterproof only when the caps and door are properly closed.
- 2.) Close the caps and door properly before use. If the unit is placed in water without the caps or door properly closed, water may enter into the unit and void your warranty.
- 3.) Dry unit completely before opening the caps or door. Do **NOT** open the caps or door if wet or in a wet environment.
- 4.) Do **NOT** apply excessive force to any surfaces of the unit when wet or in a wet environment.
- 5.) Do **NOT** use or store the unit in places with high temperature.
- 6.) **AVOID** prolonged exposure to ultraviolet radiation (UV sunlight) and strong magnetic fields.
- 7.) Periodically check the rubber seal on the caps and door for premature wear.
- 8.) Periodically clean the rubber with a soft moist cloth and ensure no objects such as dirt, hair, sand are on the rubber seal ring. Do **NOT** use any oily solvent or chemicals for cleaning.
- 9.) Rinse off the unit with tap water after use in salt water or swimming pool.
- 10.) Power and / or charge the built-in rechargeable battery for portable use by connecting the AC cord to an AC outlet.
- 11.) Noise and audio distortion may occur when the batteries are nearing end of charge.
- 12.) Do **NOT** remove the built-in battery. Do **NOT** remove the grill covers.

LIMITED MANUFACTURER'S WARRANTY:

EcoTrek is covered by a 3 year limited warranty that covers defects in workmanship and / or materials for a period of 3 years from original purchase date. This warranty does not apply to any products which have been abused, neglected, modified or used for a purpose other than the one for which they were manufactured. Please refer to the above care and maintenance instructions for suggested care details. The warranty is valid only for the original owner who purchases the unit from an authorized dealer. Transfers do not qualify for warranty protection. Grace Digital reserves the right to replace any out-of-stock or discontinued product with a comparable product. Discontinued products may not be available for warranty replacement. Any contents are **NOT** covered by the limited manufacturer's warranty. Warranty terms may be revised without notification at the discretion of the manufacturer. Please visit www.ecoxgear.com for additional product & warranty information.



EcoTrek by ECOXGEAR, a division of Grace Digital Inc., San Diego, California.

Designed in California. Made in China.

Patents Pending.