

ExtremeWhip



LED WHIP LIGHTS

User Guide | Model: SEI-SEWHP1... SEI-SEWHP6

IMPORTANT:

- Please read the User Guide before installation and use.
- The ExtremeWhip is compatible with the ECOXGEAR audio and LED lighting EcoSystem, which includes LEDCast and EcoCast Innovations. Look for the LEDCast and EcoCast logos on the growing family of ECOXGEAR and SoundExtreme audio and lighting solutions.
- The ExtremeWhip must be controlled by a SoundExtreme product with LEDCast technology (sold separately).
- Do **NOT** make modifications to the product connectors.
- Do **NOT** connect this product to any other manufacturers' LED controller.

WARNING:

- Connecting this product to any other manufacturer's product may cause permanent damage to the product and shall void the warranty.

ExtremeWhip Layout

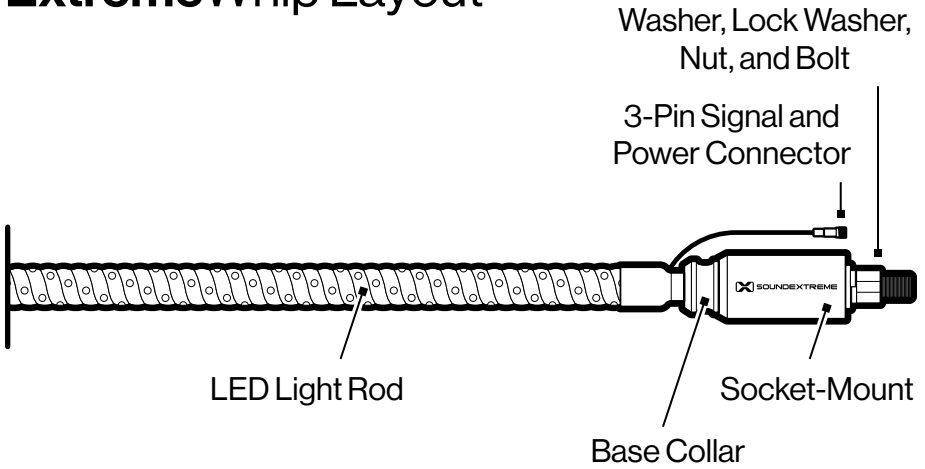

Quick Release Instructions

The LED Light Rod is held in place with magnets located between the ExtremeWhip's Base and the Socket-Mount.

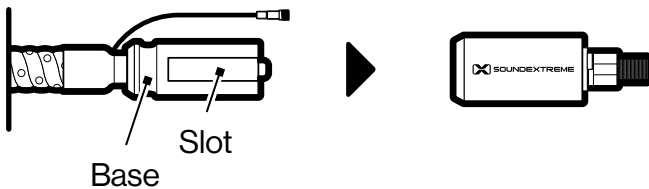

To **REMOVE** the ExtremeWhip LED Light Rod from the Socket-Mount:

1. Hold the black Socket-Mount in one hand and grab the metal collar ExtremeWhip's Base with your other hand.
2. Pull the LED Light Rod out from the Socket-Mount.

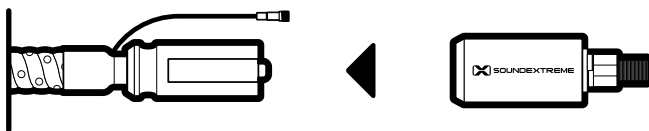

To **INSERT** the ExtremeWhip LED Light Rod into the Socket-Mount:

1. Align the Slot (flat portion) of the ExtremeWhip's Base and the flat part inside the Socket-Mount.

2. Push the LED Light Rod into the Socket-Mount.

Mounting Instructions

1. Locate a mounting hole on your vehicle where you can install your ExtremeWhip.
 - The Socket-Mount's Bolt requires a 1/2" hole on your vehicle.
 - Alternately, an optional ExtremeWhip Mount is sold separately.



2. Remove the Socket-Mount from the ExtremeWhip Base, unscrew the Nut, and also remove the Lock Washer and Washer.
3. Insert the Socket-Mount's Bolt through the mounting hole on your vehicle or on the optional ExtremeWhip Mount (sold separately).
4. Place the included Washer, Lock Washer, and Nut on the Socket-Mount's Bolt and use a wrench to tighten the Nut on the Bolt.

IMPORTANT: If the Socket-Mount is not secure, the ExtremeWhip may fall off the vehicle while it is stationary or in motion, potentially resulting in damages and/or injury.

5. Insert the ExtremeWhip LED Light Rod into the Socket-Mount.

Wiring Instructions

1. If your ExtremeWhip is not mounted near a SoundExtreme product with LEDCast technology (sold separately), run the included LED Extension Cable to the SoundExtreme product. Make sure the cable does **NOT** touch any moving parts on the vehicle. If the cable is longer than required do **NOT** cut the cable and reconnect. Instead wrap the extra length on your vehicle and fasten the cable with zip ties. Please ensure the cable does **NOT** touch or drag on the ground **AND** is safely secured to prevent it from coming into contact with any moving parts.

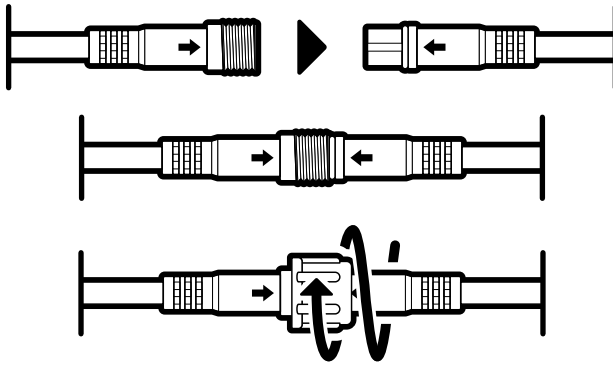

2. Connect the 3-pin male connector on the ExtremeWhip to the 3-pin female connector on the LED Extension Cable. Align the arrow on both connectors, push-in, and screw the nut cap on the female connector.
3. Connect the 3-pin male connector on the LED Extension Cable to the LED control output 3-pin female connector on a SoundExtreme product with LEDCast technology.

IMPORTANT: To avoid potential electric damage to your ExtremeWhip or the LED controller, power off your SoundExtreme product with LEDCast technology before you make the connection. Align the arrow on both connectors, push-in, and screw the nut cap on the female connector.

4. Once connected, you can change the ExtremeWhip lighting effects via the connected SoundExtreme product, which can be controlled by either a RF remote or the SoundExtreme smartphone app.

Detach From Your Vehicle

1. Power off the SoundExtreme product with LEDCast technology (sold separately) that is connected to your ExtremeWhip.

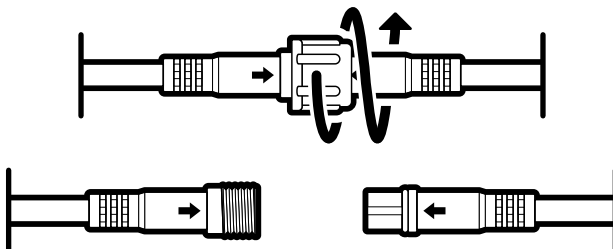

2. Unscrew the nut cap on the LED Extension Cable and disconnect the female connector on the extension cable from the 3-pin male connector on the ExtremeWhip.

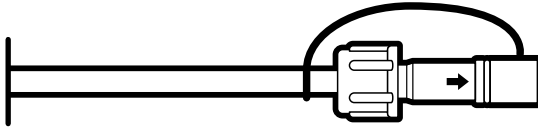

3. When disconnected, use the attached cap to cover the connector to avoid water or dust entering the connector.
4. Remove the ExtremeWhip LED Light Rod from the Socket-Mount.

Specifications

Total Length

SEI-SEWHP2: 26.42 in (67.1 cm)

SEI-SEWHP4: 48.03 in (122 cm)

Unit Weight

SEI-SEWHP2: 1.37 lbs; 1.81 lbs with flag (0.62 kg; 0.82 kg with flag)

SEI-SEWHP4: 1.90 lbs; 2.34 lbs with flag (0.86 kg; 1.06 kg with flag)

Maximum Working Current

SEI-SEWHP2: 1.6A (12V Power Supply)

SEI-SEWHP4: 2.6A (12V Power Supply)

Storage Temperature

-4°F to 122°F / -20°C to 50°C

Operating Temperature

23°F to 95°F / -5°C to 35°C

FCC STATEMENT:

This device complies with Part 15 of the FCC Rules. Operation is subject to the following two conditions:

- 1.) This device may not cause harmful interference, and
- 2.) This device must accept any interference received, including interference that may cause undesired operation.

WARNING: Changes or modifications not expressly approved by the party responsible for compliance could void the user's authority to operate the equipment.

NOTE: FCC's RF Exposure guidelines, this equipment should be installed and operated with minimum distance between 20cm the radiator to your body.

This equipment has been tested and found to comply with the limits for a Class B digital device, pursuant to Part 15 of the FCC Rules. These limits are designed to provide reasonable protection against harmful interference in a residential installation. This equipment generates, uses, and can radiate radio frequency energy and, if not installed and used in accordance with the instructions, may cause harmful interference to radio communications. However, there is no guarantee that interference will not occur in a particular installation. If this equipment does cause harmful interference to radio or television reception, which can be determined by turning the equipment off and on, the user is encouraged to try to correct the interference by one or more of the following measures: reorient or relocate the receiving antenna, increase the separation between the equipment and receiver, connect the equipment into an outlet on a circuit different from that to which the receiver is connected, consult the dealer or an experienced radio/TV technician for help.

RF WARNING STATEMENT:

The device has been evaluated to meet general RF exposure requirement. The device can be used in portable exposure condition without restriction.

IC STATEMENT:

This device complies with Industry Canada licence-exempt RSS standard(s). Operation is subject to the following two conditions:

- 1.) This device may not cause interference, and
- 2.) This device must accept any interference, including interference that may cause undesired operation of the device.

PRODUCT USE AND PROTECTION:

Read and follow all instructions. Use only as intended.

The SoundExtreme unit is intended to be used indoors or outdoors and in land or water environments. The unit has been tested to IP66 waterproofing standards, which means the unit can be exposed to dust and water, but should **NOT** be submerged underwater.

To prevent fire or shock, do **NOT** attempt to power this unit if it is wet or you suspect water has entered the unit. In this situation, please return the unit to SoundExtreme for a free assessment. If we have found that the unit has carried water, we will repair or replace the unit free of charge.

SAFETY ADVISORY & WARNING:

Read and follow all instructions. Use only as intended.

CAUTION: Do **NOT** open to repair. A qualified technician must carry out repair work.

ATTENTION: Do **NOT** connect to a SoundExtreme product with LEDCast technology while the unit is wet. Make sure all connections are dry **BEFORE** connecting to a power source. Failure to do so may result in electrical damage to the unit and may void the warranty.

⚠ WARNING: Cancer and Reproductive Harm - www.P65Warnings.ca.gov

ATTENTION: Do **NOT** dispose of in a landfill. Contact SoundExtreme at www.gracesupport.com or a certified recycling agent to dispose of the unit.

SAFETY:

This product has a limited life span of use and should be replaced when it shows obvious signs of wear.

Do not modify or remove any original component parts of the speaker. Doing so could cause damage to the unit, allowing water to ingress. A unit with water ingress should not be charged due to potential risk of fire or shock.

Please exercise care and good judgment when using your SoundExtreme unit.

You should always

- 1.) Return the unit to SoundExtreme if you suspect water ingress into the unit or if the unit has experienced a severe impact that may have affected the integrity of the unit to take on water.

You should never

- 1.) Never power your SoundExtreme unit if you suspect water has entered the device. Powering a device with water inside could be potentially hazardous and cause fire or a spark.
- 2.) Never use your SoundExtreme unit if you have dropped it or thrown it against a hard surface which may have destroyed the integrity of the housing. In the event of a severe impact to your unit, please return the unit to SoundExtreme to review for potential damage.

3.) Never attempt to fix, repair your SoundExtreme unit. Please send it back to SoundExtreme for any assessments and repairs.

CARE, MAINTENANCE & PRECAUTIONS:

- 1.) Do **NOT** apply excessive force to any surfaces of the unit.
- 2.) Do **NOT** use or store the unit in places with high temperature.
- 3.) **AVOID** prolonged exposure to ultraviolet radiation (UV sunlight) and strong magnetic fields.

LIMITED MANUFACTURER'S WARRANTY:

The ExtremeWhip is covered by a 1-year limited warranty that covers defects in workmanship and / or materials for a period of 1 year from original purchase date. This warranty does not apply to any products which have been abused, neglected, modified or used for a purpose other than the one for which they were manufactured. Please refer to the above care and maintenance instructions for suggested care details. The warranty is valid only for the original owner who purchases the unit from an authorized dealer. Transfers do not qualify for warranty protection. SoundExtreme reserves the right to replace any out-of-stock or discontinued product with a comparable product. Discontinued products may not be available for warranty replacement. Any contents are **NOT** covered by the limited manufacturer's warranty. Warranty terms may be revised without notification at the discretion of the manufacturer. Please visit www.soundextreme.us for additional product & warranty information.



ExtremeWhip by SoundExtreme Inc., Houston, Texas.
Designed in Texas. Made in China.

What's in the Box

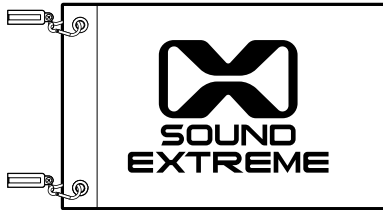

SoundExtreme Flag

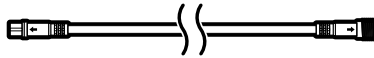

LED Extension Cable – 10 ft long

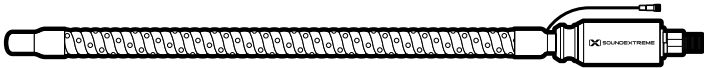

ExtremeWhip