

SoundExtreme SEB26



Models: GDI-EXSEB2600...20

RECHARGEABLE
POWERSPORTS
AMPLIFIED
SOUNDBAR



User Guide

SoundExtreme Layout

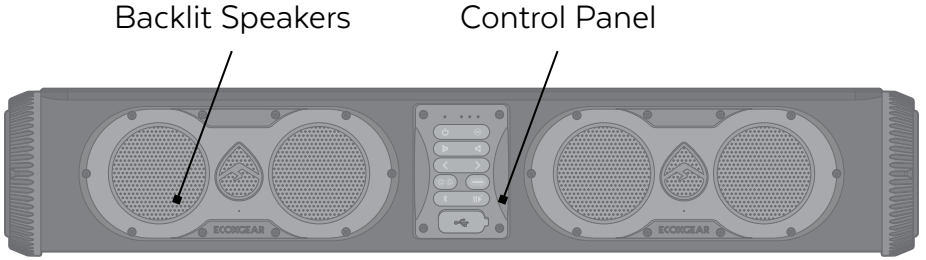

FRONT

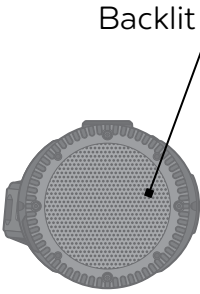

LEFT SIDE

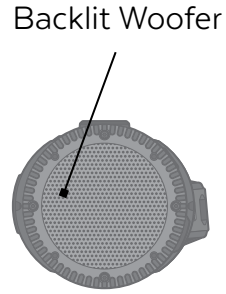

RIGHT SIDE

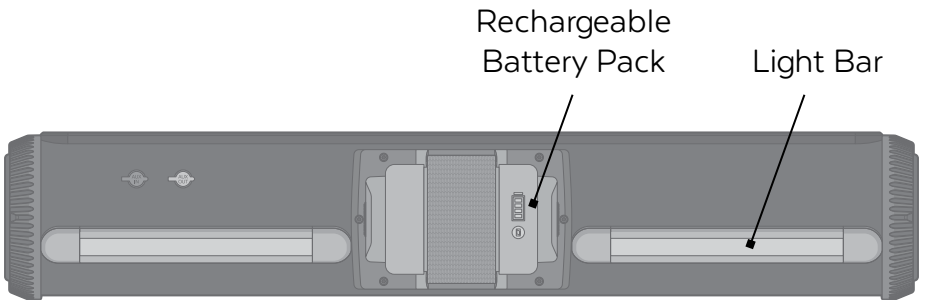

BACK

In/Out Connections

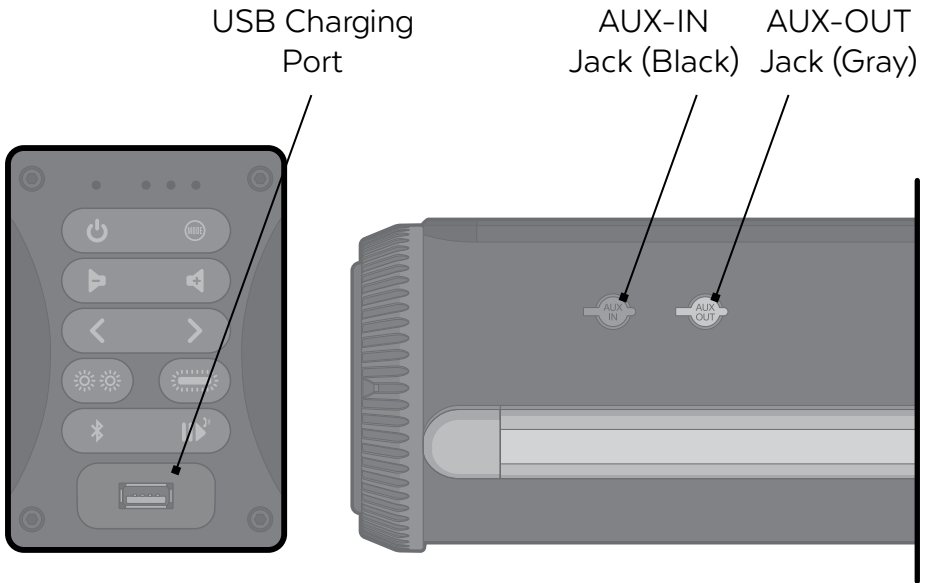

Do **NOT** use these connections if they are wet.

AUX-IN: This input can be used to connect a CD player, MP3 player, etc.

AUX-OUT: This output can be used to connect to an amplifier or to another speaker AUX-IN connection.

USB Charging Port: Connect your device's charge cable here to charge it. USB charging only functions when the SoundExtreme's power is turned on. USB port rating is 5V, 2.1A.

Important: Maintaining Waterproofness

If the caps on the control panel, the AUX-IN, and AUX-OUT Ports are not properly closed, the unit is **NOT** watertight.

To close the USB Charging Out Port properly, push firmly to be sure the cap fits flat along the edges with the panel.

To close the AUX-IN and AUX-OUT ports properly, push firmly to be sure the cap snaps securely into place.

Rechargeable Battery

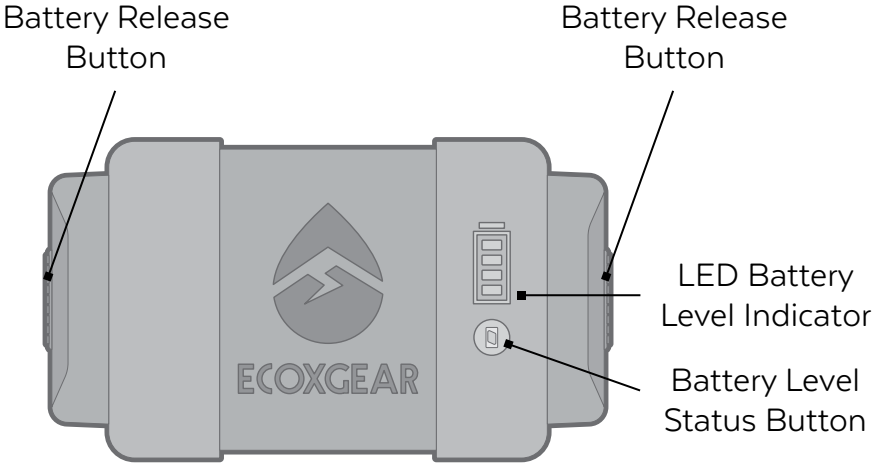

The SoundExtreme has a removable, 12V Rechargeable Battery Pack. Before using the speaker for the first time, charge the battery. It can take 8 hours to fully recharge the battery from empty.

WARNING: Only use the provided Battery Charger. Do **NOT** attempt to use an alternative charger found on the market. (Additional ECOXGEAR removable 12V Rechargeable Battery Packs and Battery Chargers sold separately.)

Recharge Battery Pack

1. Prior to first use, the Battery Pack is not installed. Instead, the Battery Port Cap has been installed to create a waterproof seal. Remove the Battery Pack from its packaging and skip to Step 5.

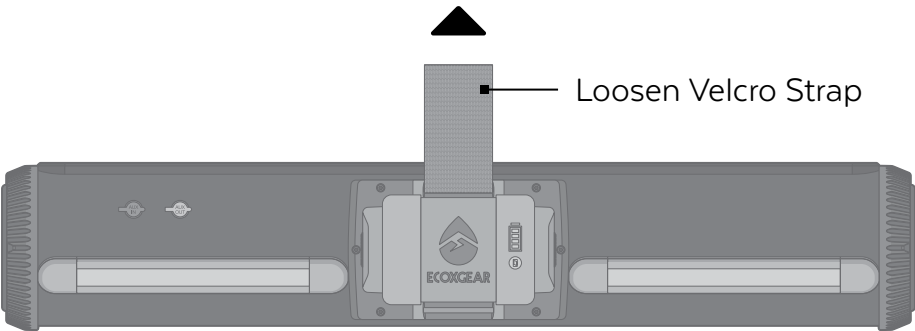

2. Loosen the velcro strap that is fastened over the Battery Pack.

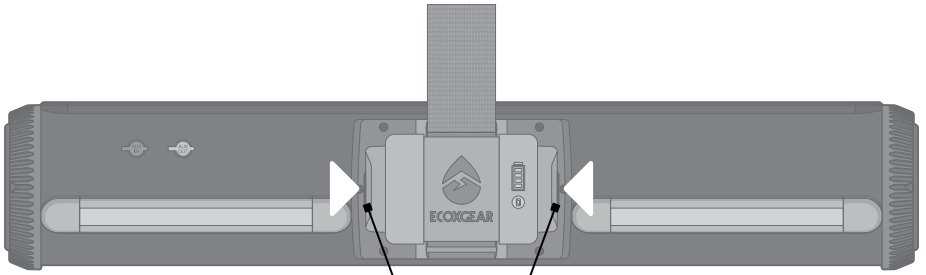

Press Battery Release Buttons

3. Remove Battery Pack by pressing the Battery Release Buttons on both sides of the battery and pulling it out of the back of the speaker.

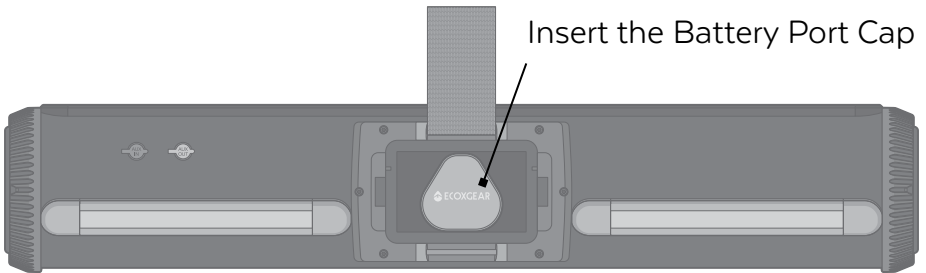
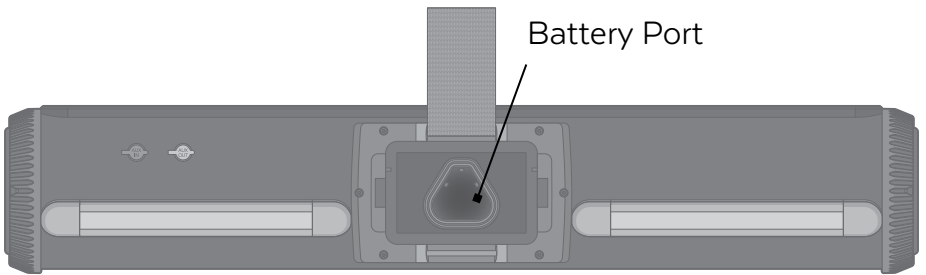

4. Insert the Battery Port Cap to create a waterproof seal while the Battery Pack is being charged.

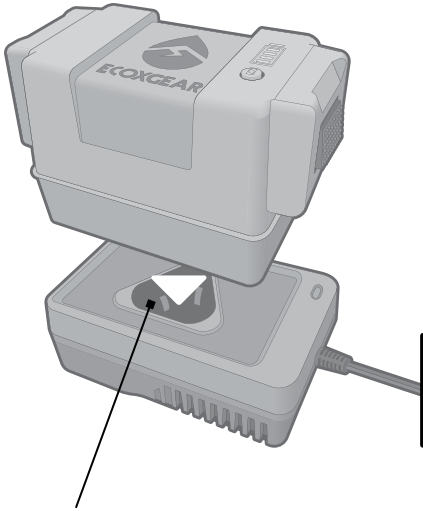

Insert Battery Pack into Battery Charger

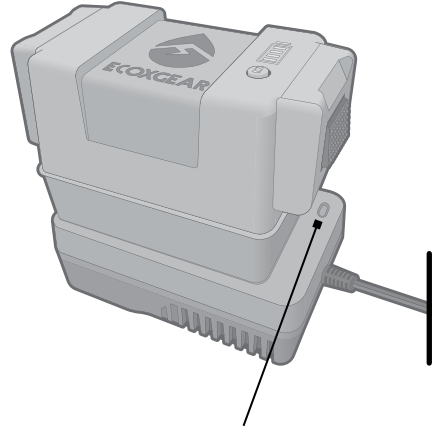

Battery Charging Indicator

5. Insert the Battery Pack into the Battery Charger.
6. Plug the Battery Charger into a wall power outlet.
7. The Battery Charging Indicator on the Battery Charger will shine red while charging.
8. You can press the Battery Level Status Button on the Battery Pack while it is charging. The LED Battery Level Indicator segments will illuminate for approximately 5 seconds. Each LED segment represents 25% of a charge. Four full LEDs indicate a full charge.
9. Once the battery is fully charged, the Battery Charging Indicator will shine green. It can take 8 hours to fully recharge the battery from empty.
10. Remove Battery Pack from the Battery Charger.
11. Remove the Battery Port Cap from the Battery Port.

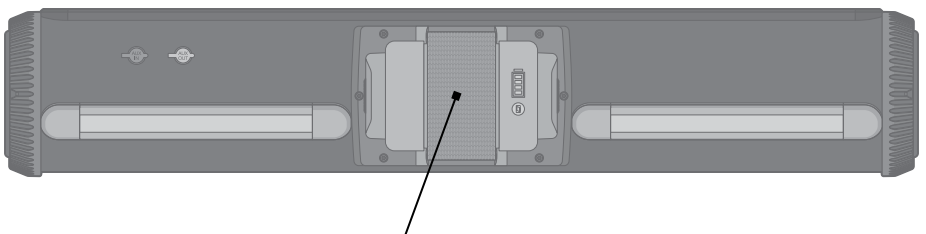

Fasten Velcro Strap

12. Insert the Battery Pack into the back of the speaker. You should hear an audible click, indicating that the Battery Pack is secure. Fasten the velcro strap over the battery.

Use Caution: Do **NOT** attempt to charge if battery is wet. Contact may cause electric shock and injury if wet. The Battery Charger is **NOT** waterproof.

Notes:

- Fully charge prior to use (6-8 hours).
- Do **NOT** leave a unit plugged in and charging continuously for more than 16 hours after the unit indicates a full charge.

Controls

1. **LED Indicators:** Each of the 4 LEDs correspond to different functions: Power, Bluetooth, Mode, and Status.
2. **Power Button:** Press button to turn the SoundExtreme on / off.
3. **Mode Button:** Press button to cycle through the following modes: Bluetooth, EcoCast Transmitting, EcoCast Receiving, FM, and AUX-IN.
4. **Volume Control Buttons:** Press to adjust the speaker's volume. Press and hold to adjust the volume continually.
5. **Track Buttons:** Press buttons to go to the previous / next track on a paired Bluetooth device.
6. **Backlight Speakers Button:** Press to cycle through the following 6 Party Light Modes: Green Light, Red Light, White Light, Blue Light, Music Sync, and Fading.
7. **Light Bar Button:** Press to cycle through the following 5 Light Modes: Red Light, Yellow Light, White Light (High), White Light (Mid), and White Light (Low). Press and hold to enable / disable Accessory Mode (which turns on /off the Auxiliary Power Out connection).
8. **Bluetooth Button:** When in Bluetooth Mode, if the Bluetooth LED Indicator is not flashing Blue, press this button to enter Bluetooth Pairing mode. If your device is paired (solid Blue LED), press button to disconnect. Press and hold this button for 5 seconds to clear all pairing records. In FM Mode, this button is used for FM Station Preset 1.
9. **Play / Pause / Answer / EcoTalk Button:** Press to play / pause a track or answer / end a mobile call from a paired Bluetooth device. Press and hold to activate your Voice Assistant (Siri and OK Google). In FM Mode, this button is used for FM Station Preset 2.



CONTROL PANEL

Operations

LED Indicators

From left to right, the 4 LED Indicators correspond to Power, Bluetooth, Mode, and Status.

1. **Power**

Solid Green: Power On

No Light: Power Off

2. **Bluetooth**

Flashing Blue: Bluetooth Paring

Solid Blue: Bluetooth Connected

3. **Mode**

Solid Blue: Speaker Mode

Solid / Flashing Red: EcoCast Transmitting Mode

Solid / Flashing Green: EcoCast Receiving Mode

4. **Status**

Solid Blue: FM

Solid Green: AUX-IN

Power On / Off

Power On: Press  briefly to power on the SoundExtreme. “Speaker on, ready to connect” voice prompt will be heard.

Power Off: Press  briefly to power off the SoundExtreme.

Mode Button

Press  briefly to cycle through the following modes: Bluetooth, EcoCast Transmitting, EcoCast Receiving, FM, and AUX-IN.









Pairing a Bluetooth Device

1. Turn on your Bluetooth device.
2. Power on SoundExtreme. “Speaker on, ready to connect” voice prompt will be heard. If the Bluetooth LED Indicator (the second LED Indicator from the left) is not flashing, briefly press  to start pairing your device.
3. Navigate to your Bluetooth device’s setup screen, find ECOXGEAR and connect. If the connection is successful, the Bluetooth icon will be lit solid and your SoundExtreme will announce “Your phone is connected.”



Notes:

- If the pairing is not complete within 5 minutes, the speaker will exit the pairing mode. You need to repeat the pairing steps again.
- After the connection is successful, if you turn the speaker off and turn it on again, it will reconnect to the last connected device automatically. Also, a voice prompt, “Speaker on, ready to connect” followed by, “Your phone is connected” will be heard.
- **PRESS AND HOLD**  for 5 seconds to clear all pairing records.

Adjust Volume



1. Press  or  briefly to adjust the speaker volume.
2. **PRESS AND HOLD**  or  to adjust the volume continuously.
 - a. Press  briefly to increase one volume level. **PRESS AND HOLD**  to keep increasing the volume until maximum volume level is reached.
 - b. Press  briefly to decrease one volume level. **PRESS AND HOLD**  to keep decreasing the volume until minimum volume level is reached.

Play Music (Bluetooth Mode)

After the SoundExtreme is connected to your Bluetooth device, press  briefly on the SoundExtreme to play, press  again to pause.

Press  briefly to play previous song. Press  briefly to get the next song.

Notes:

- Pair and connect your Bluetooth device with SoundExtreme before using this feature.
- If a call is received when you are listening to music, press  briefly on the SoundExtreme to answer the call. Press  again to end the call.
- You can also control Volume and Play / Pause music operations from your Bluetooth enabled device. When the Audio Source is via the AUX-In connection, you must use your device to control Play / Pause music operations.

EcoTalk

PRESS AND HOLD  for 3 seconds to activate the voice assistant on your device (Siri, OK Google, etc.). Once activated, the speakerphone mic on your SoundExtreme will hear your voice commands and transfer them to the voice assistant on your device.

Notes:

- Before using the EcoTalk function, your device must be connected to the SoundExtreme via Bluetooth.
- Not all devices have voice assistant functionality; refer to your device for details.

EcoCast – Broadcast Your Music to Multiple Speakers



When you have two or more SoundExtreme speakers, you can build a broadcast system by initiating EcoCast Transmitting Mode in one SoundExtreme speaker and broadcasting your music to one or more SoundExtreme speakers in EcoCast Receiving Mode.

EcoCast: First Two Speakers

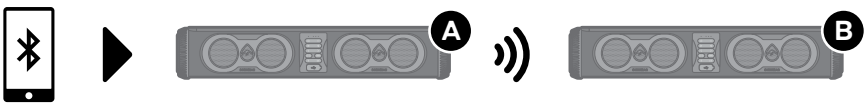

1. Follow the **Pairing a Bluetooth Device** instructions to connect one SoundExtreme (**Speaker A**) to your Bluetooth device. After your device is connected to **Speaker A**, you can select a song to play.
2. Press **MODE** on **Speaker A** to initiate EcoCast Transmitting Mode. The Mode LED Indicator (the third LED Indicator from the left) will flash Red, and the speaker will announce, “EcoCast transmitting.”
3. Power on **Speaker B** speaker and press **MODE** to cycle through to and initiate EcoCast Receiving Mode. The Mode LED Indicator will flash Green, and the speaker will announce, “EcoCast receiving.”
4. Once the connection between the speakers is successful, **Speaker B** will announce, “Connection Successful,” and start playing music from your Bluetooth device.

EcoCast: Additional Receiving Speakers

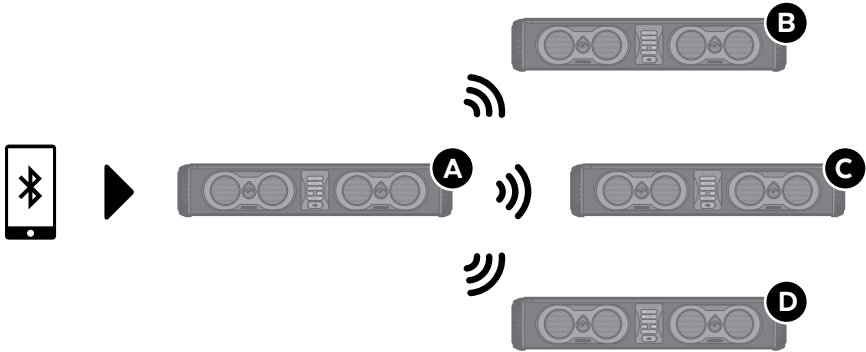





1. Power on the additional SoundExtreme speaker(s) (**Speaker C** and **Speaker D**). Press **MODE** to cycle through to and initiate EcoCast Receiving Mode. The Mode LED Indicator will flash Green, and the speaker(s) will announce, “EcoCast receiving.”
2. On **Speaker A** (the speaker with the Mode LED Indicator shining solid Red), **PRESS AND HOLD MODE** for 6 seconds. The Mode LED Indicator will flash Red.
3. Once the connection between the speakers is successful, **Speaker C** (and **Speaker D**) will announce, “Connection Successful,” and start playing music from your Bluetooth device.

Notes:

- If all the speakers are turned off, then turned on, the speaker(s) in EcoCast Receiving Mode (**Speakers B, C, and D**) will automatically re-connect to the speaker in Transmitting Mode (**Speaker A**). If they are not automatically re-connected, please follow the above steps.
- You can also pair the SoundExtreme with any other ECOXGEAR speaker bearing the EcoCast symbol .
- The EcoCast functionality is only available while using Bluetooth as your Audio Source at a maximum range of 30 feet between speakers.
- While connecting the SoundExtreme speakers, make sure that the speakers are within a few feet of each other.

Listening to FM Radio (FM Mode)

Press  briefly to cycle through to FM Mode. Press  or  briefly to tune in a radio station. To “seek” (jump to the next available station), **PRESS AND HOLD** either button down for a few seconds until it starts to seek a station.

When you tune and listen to a station, you can **PRESS AND HOLD**  to assign the current station to Preset 1, or **PRESS AND HOLD**  to assign the current station to Preset 2.

If you want to listen to a stored preset, briefly press either button to go to the stored radio station.

Party Lights



Press  briefly to cycle through 6 Party Light Modes: Green Light, Red Light, White Light, Blue Light, Music Sync, and Fading.



Press  briefly to cycle through 5 Light Modes: Red Light, Yellow Light, White Light (High), White Light (Mid), White Light (Low).

Remote Control

Pairing Your Remote Control

Before you use your Remote Control for the first time, pull and remove the plastic tab at the bottom of the Remote Control. Your Remote Control should be paired to your unit. **IF NOT** paired, please follow the steps below.

1. Press  on the SoundExtreme to turn on the speaker.
2. Within 15 seconds, **PRESS AND HOLD**  for 3 seconds. Your Remote Control will be paired with your SoundExtreme.
3. Verify that your remote control works by pressing the  to see if the speakers light up.

If the speakers do not light up, press  on the SoundExtreme to turn it off. Wait for a few seconds, press  on the SoundExtreme, and then repeat the above steps.

Once the remote is paired with the SoundExtreme, it will remain stored in the SoundExtreme's memory and should not need to be paired again.

Audio



Power Off: **PRESS AND HOLD**  for 3 seconds to power off the SoundExtreme. The remote cannot be used to turn the speaker on.

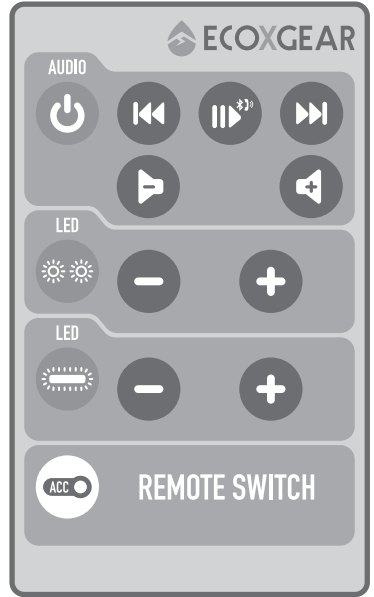

Press  briefly to cycle through the following modes: Bluetooth, EcoCast Transmitting, EcoCast Receiving, FM, and AUX-IN.





REMOTE CONTROL

After the SoundExtreme is connected to your Bluetooth device, press



 briefly to play, press  again to pause.

Press  briefly to play previous song. Press  briefly to get the next song.

Press  or  briefly to adjust the speaker volume.

LED: Backlit Speakers

Press  briefly to turn on or turn off your speaker backlights.

Press  or  briefly to cycle through the 6 Party Light modes.

LED: Light Bar

Press  briefly to turn on or turn off your Light Bar.

Press  or  briefly to cycle through the 5 Light modes.

Mounting Your Speaker

1. To mount the speaker, first place the 2 Mounts on the ends of the SoundExtreme at your desired orientation and attach them using three or four (depending on the orientation of your mount) Button Head Bolts, each. Tighten securely.
2. Ensure that the speaker fits in the desired location and mark where the mounts will be attached to your vehicle.
3. Drill holes at the desired mounting points on your vehicle, large enough for the provided $\frac{1}{4}$ -20 Bolts to fit.
4. Place the Rubber Feet on both Mounts.
5. Attach the Mounts to your vehicle with the provided $\frac{1}{4}$ -20 Bolts and Nuts. Tighten securely.

Tip: Alternatively to drilling holes into your vehicle, you can also use the provided Worm Clamps to secure the speaker to your vehicle. In order to prevent scratching /damage to your vehicle, slide the provided rubber sleeves onto the worm clamps before securing the speaker.

Note: For high-speed, high-vibration, and high-impact applications, we recommend using the provided $\frac{1}{4}$ -20 Bolt mounting solution, detailed above.

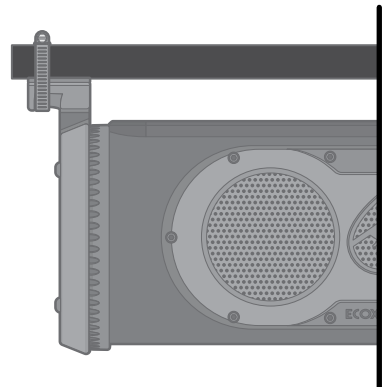
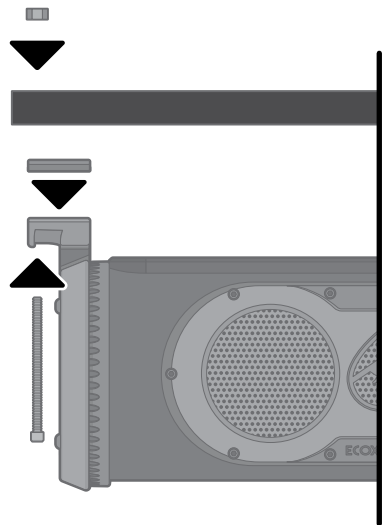
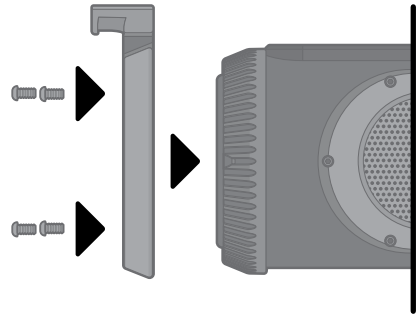

Troubleshooting

The sound is distorted

Try lowering the volume control of your connected device or musical instrument. Also, try to reduce the overall volume of the SoundExtreme.

Cannot Pair With Bluetooth Device

Make sure that your device is compatible with Bluetooth. Turn off your SoundExtreme and Bluetooth device, then power on and reconnect. Make sure that Bluetooth mode is selected on your SoundExtreme.

If there is poor FM reception

To adjust FM reception, move entire product.

Can NOT play music from a flash drive

The USB ports are only for charging USB devices.

Volume level is too low

Increase the volume on the SoundExtreme and / or increase the volume on your Bluetooth device.

LED lights for show and off-road use only

Check with local ordinance before using LED lights. Do **NOT** drive on public roads with LED lights on. LED lights are not DOT compliant.

Custom ECOXGEAR Battery Pack and Battery Charger

Only recharge the Battery Pack with the supplied Battery Charger. Additional ECOXGEAR removable 12V Rechargeable Battery Packs and Battery Chargers sold separately.

Please do NOT attempt to fix your SoundExtreme

Please contact our Customer Support at support@gracedigital.com or call us at **800.903.9524**.

⚠ WARNING: REMOTE CONTROL INCLUDES A BUTTON BATTERY



Keep the **BUTTON BATTERY** out of reach of **CHILDREN**.



If swallowed, **SEEK MEDICAL ATTENTION IMMEDIATELY**, as ingestion may lead to serious injury, chemical burns, or death.

Specifications

Dimensions

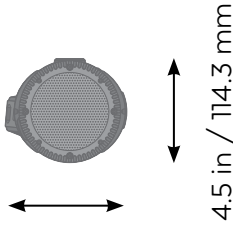

6.75 in / 171.45 mm

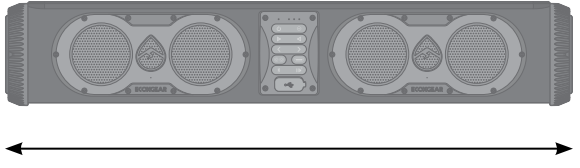

25.5 in / 647.7 mm

Unit + Mounts Height

5.75 in

Unit Weight

13 lbs

Bluetooth Compliance

Bluetooth V 5.0

Bluetooth Frequency Band

2.402-2.480GHz ISM Spectrum

Battery Charger

Input: 100 - 240 VAC

50/60Hz, 0.6A

Output: 12V, 2.0A

Bluetooth Range

Up to 100 ft / 30m

Tweeter (2x)

1" (25.4 mm) tweeter

Woofer (2x)

4" (101.6 mm) woofer

Mid-Range Speaker (4x)

2.25" (57.15mm) speaker

Audio Output Power

500W (peak)

Power Supply

12V, 13.4Ah Lithium-Ion rechargeable battery pack

USB Output

5V, 2.1A

Play Time

Up to 20hrs play time, 5hrs play time at maximum volume

Charging Time

Approximately 8 hours

EcoCast

Using Qualcomm® Broadcast Audio technology

EcoCast Range

30 ft / 9.1 m between Casting speaker and Receiving speakers

Compatibility

Mobile phone / device supporting Bluetooth V1.1 (and above)

Radio Frequency Range

US: FM 87.5 - 107.9 MHz

RF Remote Operating Frequency

433 MHz

Blade Fuse

15A, 32V

Storage Temperature

-40°F to 122°F / -40°C to 50°C

Operating Temperature

23°F to 95°F / -5°C to 35°C

Waterproof / Dust Rating

IP66

FCC STATEMENT:

This device complies with Part 15 of the FCC Rules. Operation is subject to the following two conditions:

- 1.) This device may not cause harmful interference, and
- 2.) This device must accept any interference received, including interference that may cause undesired operation.

WARNING: Changes or modifications not expressly approved by the party responsible for compliance could void the user's authority to operate the equipment.

NOTE: To maintain compliance with FCC's RF Exposure guidelines, this equipment should be installed and operated with minimum distance between 20cm the radiator to your body: Use only the supplied antenna. FCC ID: 2AAUI-GDIEXSEB2601. This equipment has been tested and found to comply with the limits for a Class B digital device, pursuant to Part 15 of the FCC Rules. These limits are designed to provide reasonable protection against harmful interference in a residential installation. This equipment generates, uses, and can radiate radio frequency energy and, if not installed and used in accordance with the instructions, may cause harmful interference to radio communications. However, there is no guarantee that interference will not occur in a particular installation. If this equipment does cause harmful interference to radio or television reception, which can be determined by turning the equipment off and on, the user is encouraged to try to correct the interference by one or more of the following measures: reorient or relocate the receiving antenna, increase the separation between the equipment and receiver, connect the equipment into an outlet on a circuit different from that to which the receiver is connected, consult the dealer or an experienced radio/TV technician for help.

RF WARNING STATEMENT:

The device has been evaluated to meet general RF exposure requirement. The device can be used in portable exposure condition without restriction.

IC STATEMENT:

This device complies with Industry Canada licence-exempt RSS standard(s). Operation is subject to the following two conditions:

- 1.) This device may not cause interference, and
- 2.) This device must accept any interference, including interference that may cause undesired operation of the device.

PRODUCT USE AND PROTECTION:

Read and follow all instructions. Use only as intended.

The ECOXGEAR Bluetooth speaker is intended to be used indoors or outdoors and in land or water environments. The speaker has been tested to IP66 waterproofing standards, which means the speaker can be exposed to dust and water, but should not be submerged underwater. The speaker is **NOT** intended for constant underwater use.

Always make sure the cap(s) / cover(s) are clean, free from sand or debris, and correctly fitted. The speaker will only meet IP66 ratings if all rubber seals, gasket(s) and cover(s) / cap(s) are in place. If you notice a muffling of audio after submersion, gently shake the unit to clear excess water. If your speaker is exposed to salt water, clean it thoroughly after use with fresh water.

The power cable and the unit with an improperly fitted cap are **NOT** waterproof.

To prevent fire or shock, do **NOT** attempt to power this unit if it is wet or you suspect water has entered the unit. In this situation, please return the unit to Grace Digital for a free assessment. If we have found that the unit has carried water, we will repair or replace the unit free of charge.

SAFETY ADVISORY & WARNING:

Read and follow all instructions. Use only as intended.

CAUTION: Do **NOT** open to repair. A qualified technician must carry out repair work.

ATTENTION: Do **NOT** remove the battery while the unit is wet. Towel dry the unit **AND** make sure all connections are dry **BEFORE** removing the battery to recharge. Failure to do so may result in electrical damage to the unit and may void the warranty.

⚠ WARNING: Cancer and Reproductive Harm - www.P65Warnings.ca.gov

WARNING: Danger of explosion if battery is incorrectly charged.

ATTENTION: Do **NOT** dispose of in a landfill. Contact Grace Digital at www.gracesupport.com or a certified recycling agent to dispose of the unit.

SAFETY:

This product has a limited life span of use and should be replaced when it shows obvious signs of wear.

Do not modify or remove any original component parts of the speaker. Doing so could cause damage to the unit, allowing water to ingress. A unit with water ingress should not be charged due to potential risk of fire or shock.

Please exercise care and good judgment when using your ECOXGEAR speaker. Audio levels should be appropriate to your environment, comply with all local regulations, and always ensure that you can hear and be aware of any potential hazards around you.

You should always

- 1.) Use the ECOXGEAR speaker in accordance with any music or noise rules and regulations.
- 2.) Properly seal the ECOXGEAR prior and after each use when in humid or water environments to avoid water damage to the internal components. Salt water / air is particularly corrosive. Always make sure that the gaskets are sealed when in a salt water environment and that the unit is properly rinsed off after use.
- 3.) Properly clean the ECOXGEAR and ensure the gaskets have no sand, dirt, or water on them prior to storage.
- 4.) Store your unit with all caps properly sealed to avoid long term internal moisture damage inside your unit.
- 5.) Completely dry and clean your ECOXGEAR prior to attempting to charge the unit.
- 6.) Return the ECOXGEAR to Grace Digital if you suspect water ingress into the unit or if the unit has experienced a severe impact that may have affected the integrity of the unit to take on water.

You should never

- 1.) Never charge your ECOXGEAR if you suspect water has entered the device. Charging a device with water inside could be potentially hazardous and cause fire or a spark.
- 2.) Never use your ECOXGEAR if you have dropped it or thrown it against a hard surface which may have destroyed the integrity of the speaker, housing, or gaskets. In the event of a severe impact to your unit, please return the unit to Grace Digital to review for potential damage.
- 3.) Never open the auxiliary doors in a water environment. This could cause water to ingress into the unit which could potentially be hazardous and cause a fire or a spark.
- 4.) Never connect a device to the auxiliary input jacks when in a water environment. The auxiliary jacks should only be used in a dry environment.
- 5.) Never attempt to fix, repair your ECOXGEAR unit. Please send it back to Grace Digital for any assessments and repairs.

CARE, MAINTENANCE & PRECAUTIONS:

- 1.) The unit is waterproof only when the caps and door are properly closed.
- 2.) Close the caps and door properly before use. If the unit is placed in water without the caps or door properly closed, water may enter into the unit and void your warranty.
- 3.) Dry unit completely before opening the caps or door. Do **NOT** open the caps or door if wet or in a wet environment.
- 4.) Do **NOT** apply excessive force to any surfaces of the unit when wet or in a wet environment.
- 5.) Do **NOT** use or store the unit in places with high temperature.
- 6.) **AVOID** prolonged exposure to ultraviolet radiation (UV sunlight) and strong magnetic fields.
- 7.) Periodically check the rubber seal on the caps and door for premature wear.
- 8.) Periodically clean the rubber with a soft moist cloth and ensure no objects such as dirt, hair, sand are on the rubber seal ring. Do **NOT** use any oily solvent or chemicals for cleaning.
- 9.) Rinse off the unit with tap water after use in salt water.
- 10.) Noise and audio distortion may occur when the batteries are nearing end of charge.
- 11.) Do **NOT** remove the grill covers.

LIMITED MANUFACTURER'S WARRANTY:

SoundExtreme is covered by a 1-year limited warranty that covers defects in workmanship and / or materials for a period of 1 year from original purchase date. This warranty does not apply to any products which have been abused, neglected, modified or used for a purpose other than the one for which they were manufactured. Please refer to the above care and maintenance instructions for suggested care details. The warranty is valid only for the original owner who purchases the unit from an authorized dealer. Transfers do not qualify for warranty protection. Grace Digital reserves the right to replace any out-of-stock or discontinued product with a comparable product. Discontinued products may not be available for warranty replacement. Any contents are **NOT** covered by the limited manufacturer's warranty. Warranty terms may be revised without notification at the discretion of the manufacturer. Please visit www.ecoxgear.com for additional product & warranty information.



SoundExtreme SEB26 by ECOXGEAR, a division of Grace Digital Inc., San Diego, California.
Designed in California. Made in China.

This product is protected under patents 9,307,307 B2, 11,223,886, and D9372445I.





What's in the Box



SoundExtreme Speaker



(2x) Rubber Sleeves



Allen Wrench for 1/4-20



SoundExtreme User Guide



SoundExtreme Remote Control



(2x) 1/4-20 SHCS Bolt - 3.5" long



Rechargeable Battery Pack

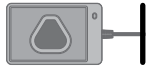

Battery Charger



(2x) 1/4-20 SHCS Bolt - 2" long



(2x) 1/4-20 Stud - 1.5" long



Battery Port Cap

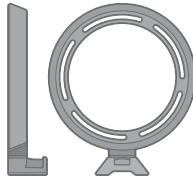

(2x) Mounts



(2x) 1/4-20 SHCS Bolt - 1.25" long



(2x) 1/4-20 SHCS Bolt - 0.5" long



(8x) #8-32 Button Head Bolts



(2x) 1/4-20 Washer (S)



(2x) Rubber Feet

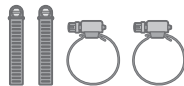

(4x) Worm Clamps - 1/2" Width



(2x) 1/4-20 Washer (L)



(2x) 1/4-20 Nut